



# ATP<sup>®</sup> Acoustic Panels

ATP<sup>®</sup> is a brand of acoustic treatment panels that belongs to JOCAVI GROUP<sup>®</sup>. Its main objective is to manufacture a line of efficient and inexpensive products. This efficient acoustic treatment is accessible to all and, in particular, to those projects that do not need a large financial investment. The ATP<sup>®</sup> range has a variety of available models which enable the application of practical solutions in rooms, home-studios, home-cinemas, rehearsal rooms, etc.

As part of the JOCAVI<sup>®</sup>, ATP<sup>®</sup> shares the engagement and experience of this organisation where high quality standards must always be attained. ATP<sup>®</sup> has its own plant, which is totally independent from that of JOCAVI<sup>®</sup> Acoustic Panels, modern machines, as well as production and manufacturing techniques of acoustic foam and polyurethane.



# CORALREEF®

DIFFUSION PANEL

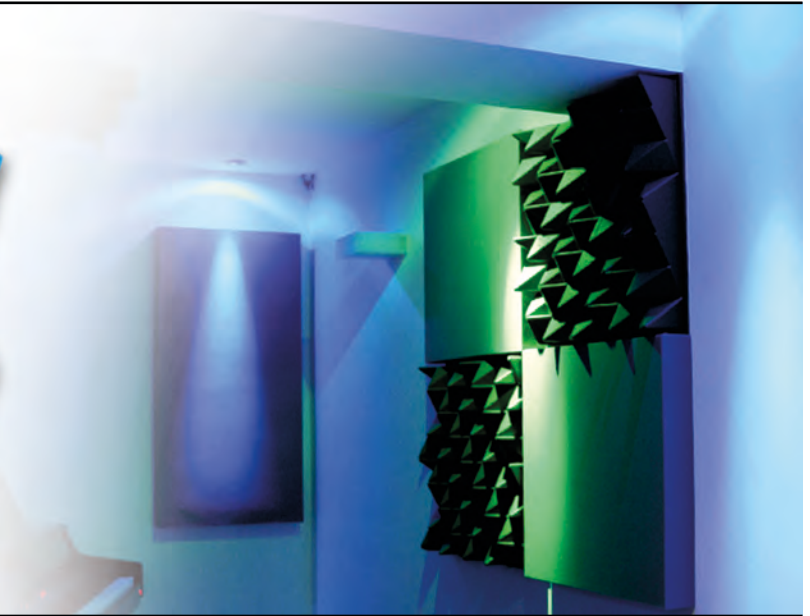
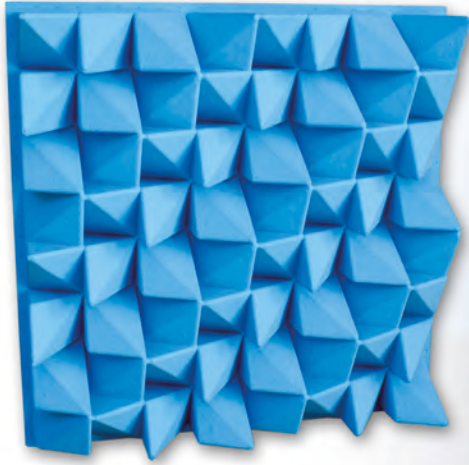

Image of 60x60cm model Ref.:COR060.

## DESCRIPTION

The CORALREEF® is a 3D controlled dispersion acoustic diffusion panel. It is made of high-density polystyrene and its finishing membrane provides it with the intended acoustic qualities.

Its angular appearance gives dynamics to any space and provides a decorative effect and attractive combinations.

This acoustic panel is installed on ceilings and walls. Its low weight makes it the ideal product for use on false ceilings, on its own or alternated with flat modules when refinement and quality are required.

The calculation basis was the theoretical numerical sequence ratio of the primitive root, thus providing excellent results of sound diffusion in all directions. The depth factor is logarithmically varied, and it is, therefore, a three-dimension omnidirectional reflection panel. Due to its quite sinuous shape with deep recesses, as well as the raw material it is made of, this product also has a considerable associated absorption coefficient.

Is the top model of ATP® diffusers set.

## TECHNICAL DRAWINGS

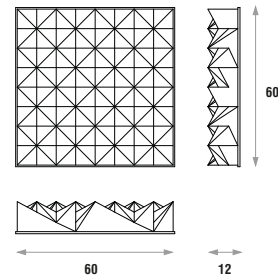

## FEATURES

- Manufactured with High-Density EPS.
- Average diffusion: **0.68/m²** [ $>100\text{Hz}; <5\text{KHz}$ ].
- NRC: **0.28/m²** [ $>100\text{Hz}; <5\text{KHz}$ ].
- Fire resistance: Euroclass B-s3,d1 (similar to old M1).
- Finished with an ecological paint.
- 100% recyclable.

## MODELS AND SIZES

MODELS	HEIGHT	WIDTH	DEPTH	WEIGHT
COR060	60 cm	60 cm	12 cm	1.9 Kg

## DIFFUSION - ABSORPTION COEFFICIENT

	0.09	0.22	0.34	0.43	0.59	0.62	0.68	0.73	0.65	0.66	0.69	0.74	0.70	0.68	0.66	0.68	0.72	0.75	0.76	0.72	0.70	0.62	0.58	0.49	<b>0.68</b>
$\alpha_S$	0.00	0.00	0.02	0.06	0.07	0.10	0.21	0.36	0.50	0.39	0.28	0.22	0.26	0.29	0.31	0.24	0.20	0.17	0.18	0.13	0.11	0.09	0.07	0.08	0.28

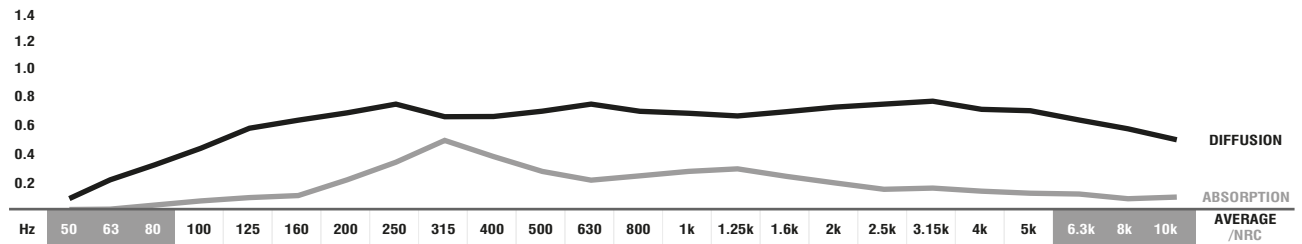

■ ABSORPTION COEFFICIENT: Values in accordance with the standards: EN 20654, ASTM C423 and EN 11654.

■ Values [ $<100\text{Hz}$  and  $>5\text{K}$ ] are Non Standard Values.

■ DIFFUSION COEFFICIENT: These values were obtained by mathematical calculations and tests carried out in our laboratory.

## STANDARD EPS RAL COLOURS

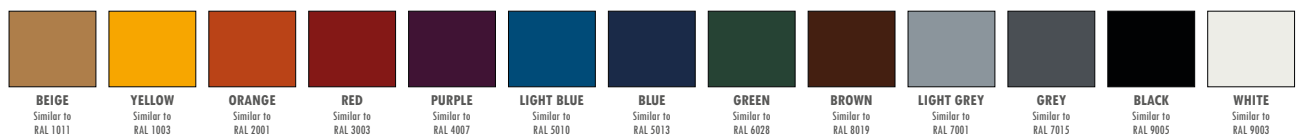

## IMPORTANT NOTICES

- JOCAVI® accepts no responsibility for any printing errors. Specifications can be modified without prior notice, if technical or commercial reasons so require.
- RAL® is an international independent colour standard system partner for industry, trade, architecture and design. Should be consulted before placing any order.
- The colours shown on this catalogue are only a reference and an illustration of the products finishing. The colours shown are not binding because brightness, contrast and colour balance may vary due to the printing process.
- Colours may vary due to raw-material suppliers' changes and some differences may occur in tonal range.
- Typical Indoor Comfort Standards state a temperature range of 20°C - 27°C (68°F - 81°F), and a relative humidity of less than 60%. These would be considered as normal operational levels of JOCAVI® products' range.
- Sizes may vary slightly due to their production method and some inherent raw-materials characteristics.





# CUBEFUSER®

DIFFUSION PANEL

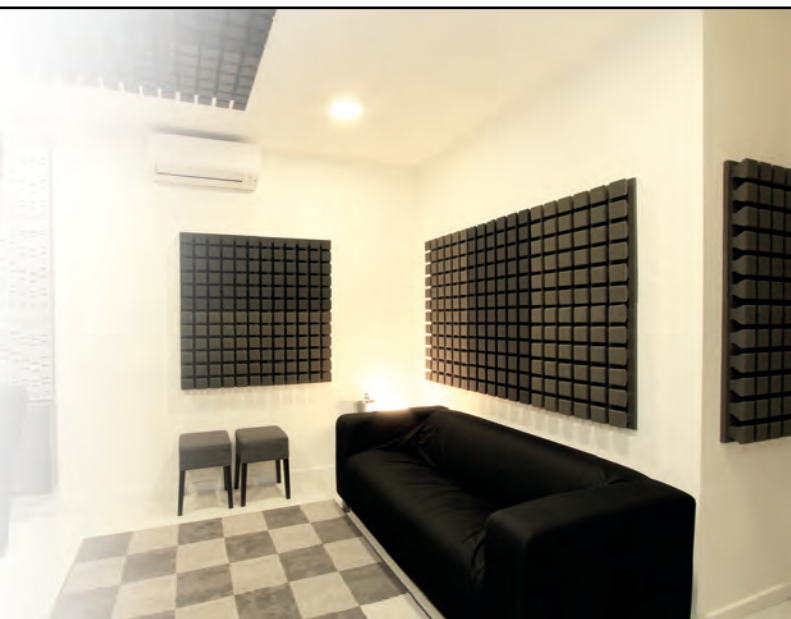
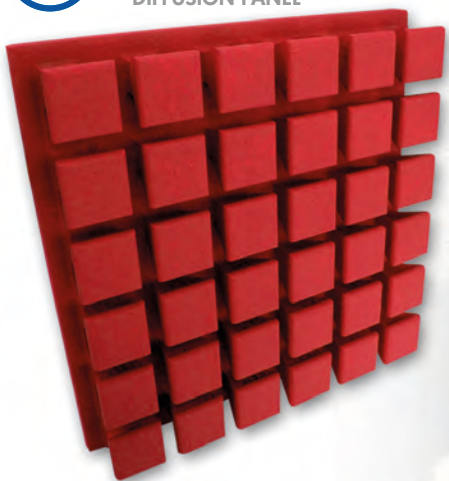

Image of 60x60cm model Ref.:CUF060 (on the left) and Ref.:CUF060 applied (ambient image).

## DESCRIPTION

The CUBEFUSER® acoustic panel is one of the least expensive diffusers from our brand. It is cubic-shaped and is made of high-quality 100% recyclable ecologic EPS raw material.

This model can be combined with the CUBESORB®; as a result, two different acoustic areas keep maintaining the same shape.

The CUBEFUSER® offers associate absorption, because the uniformly protruding cubes make the sound to enter directly into the concavities. This diffuser offers uniform unidirectional diffusion and provides an attractive design to ceilings and walls.

It is a cost-effective diffusion panel as an alternative to other more expensive diffusers.

## TECHNICAL DRAWINGS

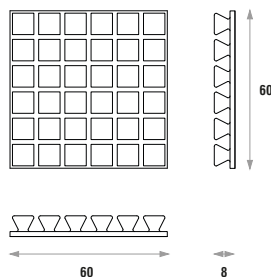

## FEATURES

- Average diffusion: **0.50/m²** [ $>100\text{Hz}; <5\text{KHz}$ ].
- NRC: **0.47/m²** [ $>100\text{Hz}; <5\text{KHz}$ ].
- Fire resistance: Euroclass B-s3,d1 (similar to old M1).
- Very easy to install.
- Other colours available upon consultation.

## MODELS AND SIZES

MODELS	HEIGHT	WIDTH	DEPTH	WEIGHT
CUF060	60 cm	60 cm	8 cm	0.5 Kg

## DIFFUSION - ABSORPTION COEFFICIENT

	0.04	0.04	0.09	0.16	0.25	0.32	0.34	0.36	0.39	0.40	0.44	0.49	0.55	0.63	0.67	0.66	0.68	0.65	0.65	0.68	0.70	0.71	0.70	0.70	<b>0.50</b>
$\alpha_S$	0.05	0.06	0.08	0.14	0.22	0.28	0.33	0.44	0.49	0.48	0.48	0.47	0.46	0.46	0.49	0.53	0.55	0.60	0.63	0.70	0.77	0.80	0.83	0.82	0.47

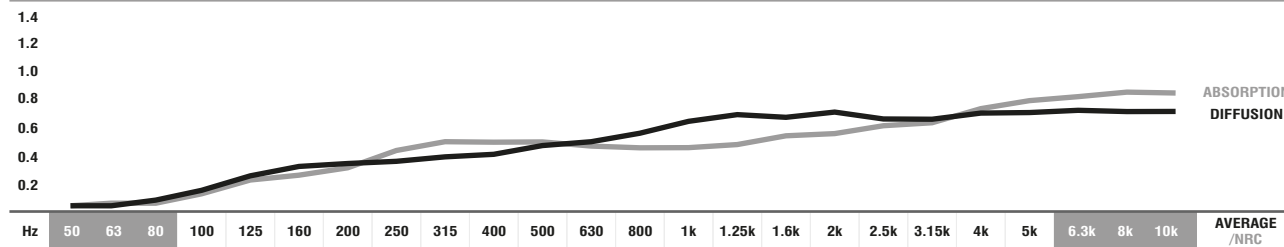

■ ABSORPTION COEFFICIENT: Values in accordance with the standards: EN 20654, ASTM C423 and EN 11654. ■ Values [ $<100\text{Hz}$  and  $>5\text{K}$ ] are Non Standard Values.  
 ■ DIFFUSION COEFFICIENT: These values were obtained by mathematical calculations and tests carried out in our laboratory.

## STANDARD EPS RAL COLOURS

BEIGE Similar to RAL 1011	YELLOW Similar to RAL 1003	ORANGE Similar to RAL 2001	RED Similar to RAL 3003	PURPLE Similar to RAL 4007	LIGHT BLUE Similar to RAL 5010	BLUE Similar to RAL 5013	GREEN Similar to RAL 6028	BROWN Similar to RAL 8019	LIGHT GREY Similar to RAL 7001	GREY Similar to RAL 7015	BLACK Similar to RAL 9005	WHITE Similar to RAL 9003

## IMPORTANT NOTICES

- JOCAVI® accepts no responsibility for any printing errors. Specifications can be modified without prior notice, if technical or commercial reasons so require.
- RAL® is an international independent colour standard system partner for industry, trade, architecture and design. Should be consulted before placing any order.
- The colours shown on this catalogue are only a reference and an illustration of the products finishing. The colours shown are not binding because brightness, contrast and colour balance may vary due to the printing process.
- Colours may vary due to raw-material suppliers' changes and some differences may occur in tonal range.
- Typical Indoor Comfort Standards state a temperature range of 20°C - 27°C (68°F - 81°F), and a relative humidity of less than 60%. These would be considered as normal operational levels of JOCAVI® products' range.
- Sizes may vary slightly due to their production method and some inherent raw-materials characteristics.







**IVORY®**  
DIFFUSION PANEL



Image of 60x60cm model Ref.:IV0060.

## DESCRIPTION

The IVORY® is a 2D controlled dispersion diffusion panel in a single coordinate. It is made of high-density EPS covered with a hardened layer. This design gives this product the intended acoustic diffusion properties. It is therefore one more option within the range of diffusers presented by ATP®.

Its convex external geometry with seven longitudinal incisions provides a decorative effect and attractive combinations with the absorption panel EBONY®.

The use of this extremely dynamic panel is crucial to control early reflections and other reflections from walls, thus improving control of sound diffusion in the room.

Due to its shape, with deep recesses, this product also has an interesting related absorption coefficient.

This acoustic panel is installed on walls and ceilings. Its low weight makes its installation on ceilings quite practical.

## TECHNICAL DRAWINGS

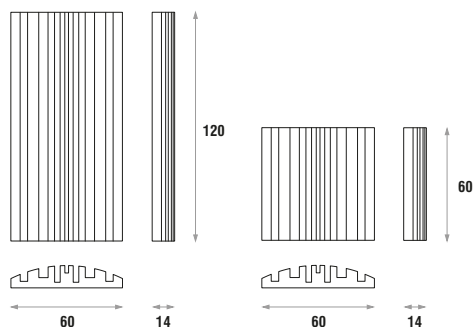

## FEATURES

- Manufactured with High-density EPS.
- Average diffusion: **0.67/m²** [ $>100\text{Hz}; <5\text{KHz}$ ].
- NRC: **0.27/m²** [ $>100\text{Hz}; <5\text{KHz}$ ].
- Fire resistance: Euroclass B-s3,d1 (similar to old M1).
- Finished with an ecological paint.
- 100% recyclable.

## MODELS AND SIZES

MODELS	HEIGHT	WIDTH	DEPTH	WEIGHT
IVO120	120 cm	60 cm	14 cm	4.8 Kg
IVO060	60 cm	60 cm	14 cm	2.4 Kg

## DIFFUSION - ABSORPTION COEFFICIENT

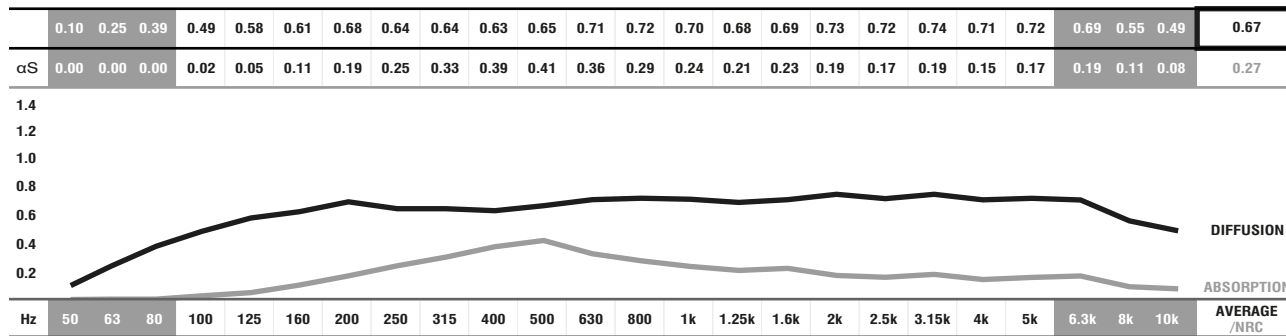

■ ABSORPTION COEFFICIENT: Values in accordance with the standards: EN 20654, ASTM C423 and EN 11654.

■ Values [ $<100\text{Hz}$  and  $>5\text{K}$ ] are Non Standard Values.

■ DIFFUSION COEFFICIENT: These values were obtained by mathematical calculations and tests carried out in our laboratory.

## STANDARD EPS RAL COLOURS

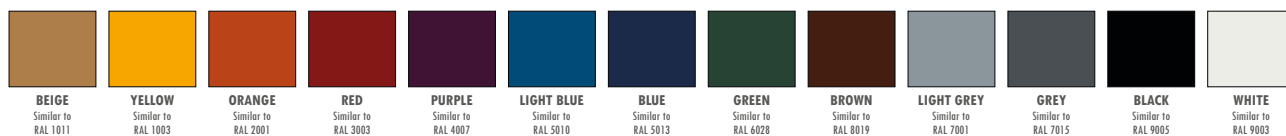

## IMPORTANT NOTICES

- JOCAVI® accepts no responsibility for any printing errors. Specifications can be modified without prior notice, if technical or commercial reasons so require.
- RAL® is an international independent colour standard system partner for industry, trade, architecture and design. Should be consulted before placing any order.
- The colours shown on this catalogue are only a reference and an illustration of the products finishing. The colours shown are not binding because brightness, contrast and colour balance may vary due to the printing process.
- Colours may vary due to raw-material suppliers' changes and some differences may occur in tonal range.
- Typical Indoor Comfort Standards state a temperature range of 20°C - 27°C (68°F - 81°F), and a relative humidity of less than 60%. These would be considered as normal operational levels of JOCAVI® products' range.
- Sizes may vary slightly due to their production method and some inherent raw-materials characteristics.





# WAVYFUSER® /INVERTED

DIFFUSION PANEL



Image of 60x60cm models Ref.:WAV060 and Ref.:WAI060 (on the left) and Ref.:WAV120 and Ref.:WAI120 applied (ambient image).

## DESCRIPTION

The WAVYFUSER INV® is made of high-quality 100% recyclable ecologic EPS raw material. This design results from combining a sequence of concave and convex shapes with numerical techniques, which creates a profile surface that optimises the scattering of diffusion.

This model has two different varieties, male and female, which, when combined in the assembly, make the diffusion of medium/low frequencies more efficient. Acoustically, this translates into a more real control of sound reflections in your room, by providing uniform omnidirectional broad bandwidth diffusion without any other unwanted sound effect in the room.

The WAVYFUSER INV® is one of the top model of ATP® diffusers set. Its price is highly reasonable and provides a combination of hemispherical acoustic diffusion with a top-quality EPS finishing painting.

## FEATURES

- Average diffusion: **0.57/m²** [ $>100\text{Hz}$ ;  $<5\text{KHz}$ ].
- NRC: **0.21/m²** [ $>100\text{Hz}$ ;  $<5\text{KHz}$ ].
- Fire resistance: Euroclass B-s3,d1 (similar to old M1).
- Finished with an ecological paint.
- Very easy to install.
- Other colours available upon consultation.
- Sold in pairs.

## TECHNICAL DRAWINGS

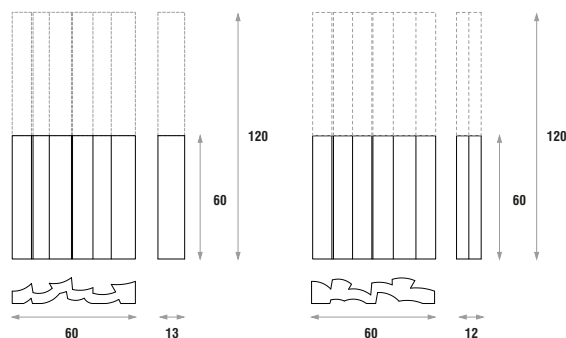

## MODELS AND SIZES

MODELS	HEIGHT	WIDTH	DEPTH	WEIGHT
WAV/120	120 cm	60 cm	13/12 cm	1/1.1 Kg
WAV/060	60 cm	60 cm	13/12 cm	2/2.2 Kg

SOLD IN PAIRS

## DIFFUSION - ABSORPTION COEFFICIENT

	0.12	0.12	0.15	0.28	0.30	0.37	0.38	0.43	0.44	0.46	0.50	0.55	0.63	0.64	0.66	0.71	0.75	0.77	0.79	0.78	0.79	0.77	0.77	0.76	<b>0.57</b>
$\alpha_S$	0.01	0.02	0.02	0.09	0.13	0.14	0.16	0.19	0.20	0.26	0.31	0.30	0.25	0.26	0.26	0.23	0.20	0.17	0.19	0.21	0.18	0.18	0.16	0.15	0.21

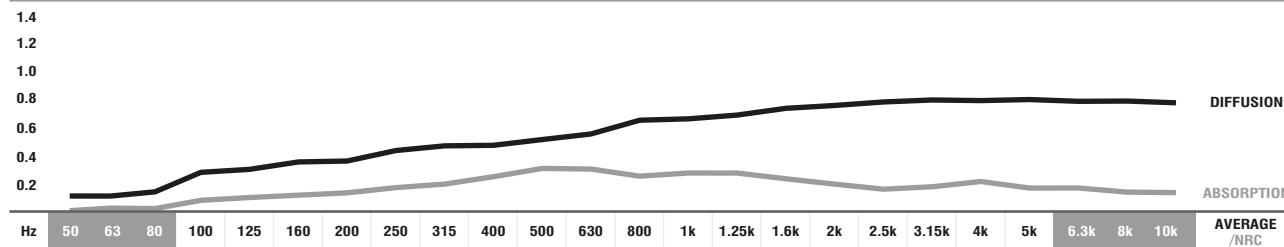

■ ABSORPTION COEFFICIENT: Values in accordance with the standards: EN 20654, ASTM C423 and EN 11654. ■ Values [ $<100\text{Hz}$  and  $>5\text{K}$ ] are Non Standard Values.  
 ■ DIFFUSION COEFFICIENT: These values were obtained by mathematical calculations and tests carried out in our laboratory.

## STANDARD EPS RAL COLOURS

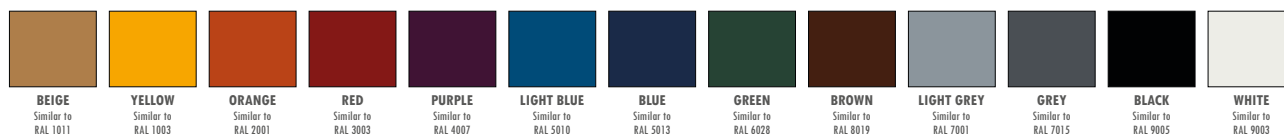

## IMPORTANT NOTICES

- JOCAVI® accepts no responsibility for any printing errors. Specifications can be modified without prior notice, if technical or commercial reasons so require.
- RAL® is an international independent colour standard system partner for industry, trade, architecture and design. Should be consulted before placing any order.
- The colours shown on this catalogue are only a reference and an illustration of the products finishing. The colours shown are not binding because brightness, contrast and colour balance may vary due to the printing process.
- Colours may vary due to raw-material suppliers' changes and some differences may occur in tonal range.
- Typical Indoor Comfort Standards state a temperature range of 20°C - 27°C (68°F - 81°F), and a relative humidity of less than 60%. These would be considered as normal operational levels of JOCAVI® products' range.
- Sizes may vary slightly due to their production method and some inherent raw-materials characteristics.





# PYRAMID®

DIFFUSION, ABSORBENT AND DIFFUSION/ABSORBENT PANEL

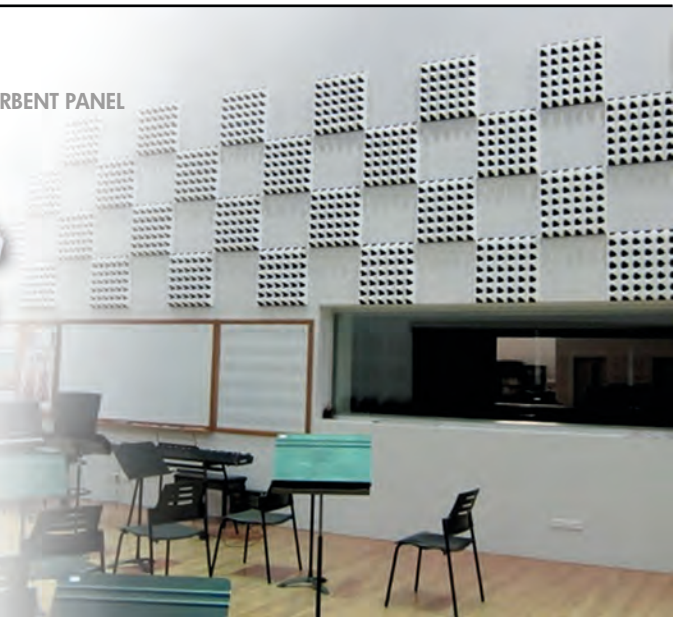
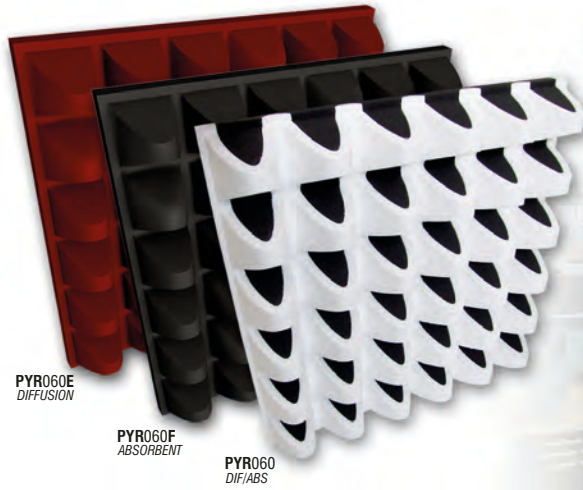

Image of 60x60cm models Ref.:PYR060 and PYR060F (on the left) and Ref.:PYR060 applied (ambient image).

DIFFUSION, ABSORBENT AND DIFFUSION / ABSORBENT PANEL

## DESCRIPTION

PYRAMID® is a model that combines diffusion and absorption qualities it was devised for the acoustic music industry to enable different acoustic characteristics with the same aspect.

This design was based on a quadratic format with flat absorption surfaces made of acoustic foam and on curved diffusion surfaces made of EPS which give it a superior balance, aural and visual performance.

The original PYRAMID®(PYR060), made on EPS and Acoustic Foam combines hemispherical acoustical diffusion and absorption in the same panel, and therefore the most balanced element from ATP's catalogue.

There are two other options; PYR060F an absorbent made on Acoustic Foam and the PYR060E that is a diffusor made on EPS.

These 3 options were designed to be applied, glued on walls and ceilings, on the modular or continuous applications, it is allowed to set on T-Ceilings as well.

## TECHNICAL DRAWINGS

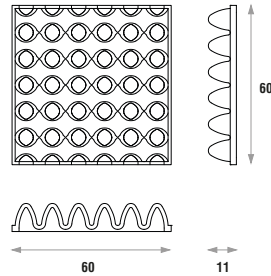

## FEATURES\*

- Average diffusion: **0.45/m²** [ $>100\text{Hz}; <5\text{KHz}$ ].
- NRC: **0.75/m²** [ $>250\text{Hz}; <10\text{KHz}$ ].
- Fire resistance: Regular Foam - Euroclass B-s3,d1 (similar to old M1); EPS - Euroclass B-s3,d1 (similar to old M1).
- Finished with an ecological paint (only PYR060E model).
- Very easy to install

## MODELS AND SIZES

MODELS	HEIGHT	WIDTH	DEPTH	WEIGHT
PYR060	60 cm	60 cm	11 cm	0.50 Kg
PYR060F	60 cm	60 cm	11 cm	0.40 Kg
PYR060E	60 cm	60 cm	11 cm	0.45 Kg

## DIFFUSION - ABSORPTION COEFFICIENT\*

	0.02	0.02	0.07	0.13	0.20	0.29	0.31	0.36	0.35	0.35	0.37	0.40	0.46	0.53	0.55	0.57	0.60	0.65	0.65	0.68	0.66	0.64	0.64	0.60	0.45
$\alpha_S$	0.04	0.04	0.03	0.03	0.08	0.13	0.23	0.32	0.40	0.51	0.64	0.79	0.86	0.91	0.94	0.92	0.89	0.83	0.78	0.77	0.80	0.81	0.81	0.82	0.75

■ ABSORPTION COEFFICIENT: Values in accordance with the standards: EN 20654, ASTM C423 and EN 11654.

■ DIFFUSION COEFFICIENT: These values were obtained by mathematical calculations and tests carried out in our laboratory.

■ Values [ $<100\text{Hz}$  and  $>5\text{K}$ ] are Non Standard Values.

\*PANEL DATA ONLY OF REF: PYR060 EPS AND FOAM MODEL.

## STANDARD EPS RAL COLOURS



## REGULAR FOAM COLOURS

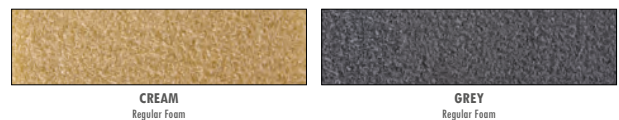

## IMPORTANT NOTICES

- JOCAVI® accepts no responsibility for any printing errors. Specifications can be modified without prior notice, if technical or commercial reasons so require.
- RAL® is an international independent colour standard system partner for industry, trade, architecture and design. Should be consulted before placing any order.
- The colours shown on this catalogue are only a reference and an illustration of the products finishing. The colours shown are not binding because brightness, contrast and colour balance may vary due to the printing process.
- Colours may vary due to raw-material suppliers' changes and some differences may occur in tonal range.
- Typical Indoor Comfort Standards state a temperature range of 20°C - 27°C (68°F - 81°F), and a relative humidity of less than 60%. These would be considered as normal operational levels of JOCAVI® products' range.
- Sizes may vary slightly due to their production method and some inherent raw-materials characteristics.





# STRIPEFUSER®

DIFFUSION PANEL

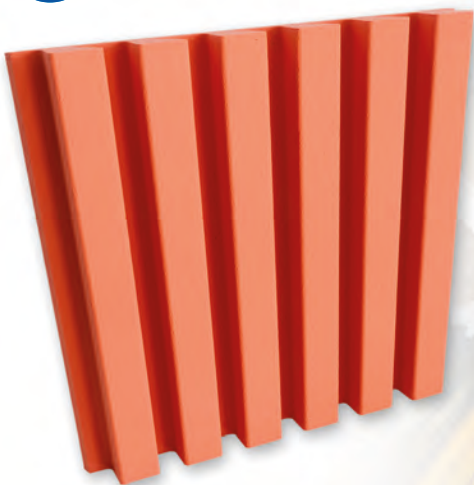

Image of 60x60cm model Ref.:STF060 (on the left) and Ref.:STF060 and STF120 applied (ambient image).

## DESCRIPTION

The STRIPEFUSER® acoustic panel is the least expensive model of diffusers from our brand. It has a striped shape and is made of high-quality 100% recyclable ecologic EPS raw material.

This model can be combined with the STRIPESORB®; as a result, two different acoustic areas keep maintaining the same shape.

The STRIPEFUSER® offers associate absorption because the uniform protruding stripes make the sound to enter directly into the concavities. This product offers uniform unidirectional diffusion and provides an attractive design to ceilings and walls.

It is a cost-effective diffuser as an alternative to other more expensive diffusion panels.

## TECHNICAL DRAWINGS

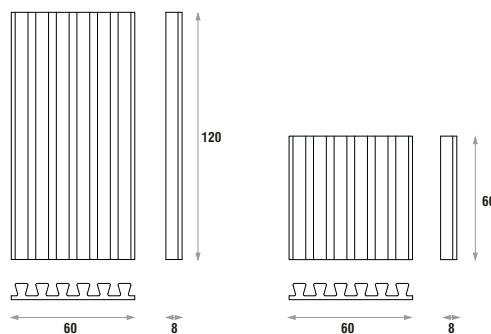

## FEATURES

- Average diffusion: **0.52/m²** [ $>100\text{Hz}; <5\text{KHz}$ ].
- NRC: **0.26/m²** [ $>100\text{Hz}; <5\text{KHz}$ ].
- Fire resistance: Euroclass B-s3,d1 (similar to old M1).
- Finished with an ecological paint.
- Very easy to install.
- Other colours available upon consultation.

## MODELS AND SIZES

MODELS	HEIGHT	WIDTH	DEPTH	WEIGHT
STF120	120 cm	60 cm	8 cm	1.5 Kg
STF060	60 cm	60 cm	8 cm	0.6 Kg

## DIFFUSION - ABSORPTION COEFFICIENT

	0.04	0.04	0.11	0.21	0.27	0.34	0.37	0.40	0.44	0.45	0.46	0.51	0.58	0.62	0.66	0.65	0.65	0.64	0.62	0.70	0.73	0.75	0.75	0.74	<b>0.52</b>
$\alpha_S$	0.01	0.01	0.05	0.11	0.16	0.16	0.19	0.20	0.22	0.29	0.33	0.31	0.30	0.27	0.28	0.30	0.31	0.33	0.32	0.33	0.29	0.25	0.23	0.22	0.26

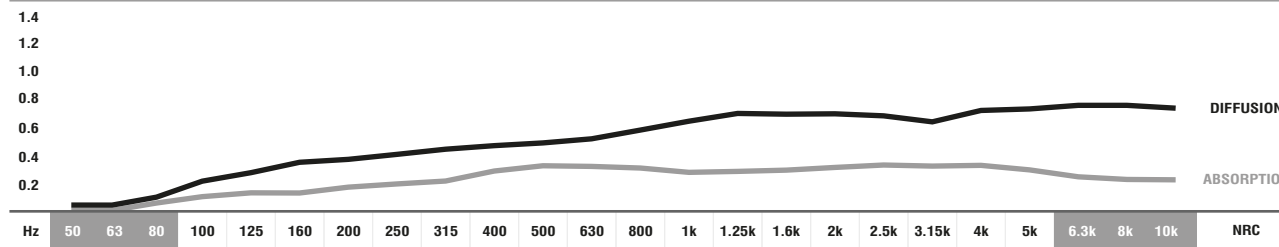

■ ABSORPTION COEFFICIENT: Values in accordance with the standards: EN 20654, ASTM C423 and EN 11654. ■ Values [ $<100\text{Hz}$  and  $>5\text{K}$ ] are Non Standard Values.  
 ■ DIFFUSION COEFFICIENT: These values were obtained by mathematical calculations and tests carried out in our laboratory.

## STANDARD EPS RAL COLOURS

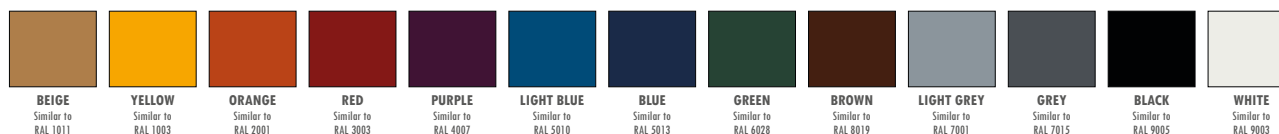

## IMPORTANT NOTICES

- JOCAVI® accepts no responsibility for any printing errors. Specifications can be modified without prior notice, if technical or commercial reasons so require.
- RAL® is an international independent colour standard system partner for industry, trade, architecture and design. Should be consulted before placing any order.
- The colours shown on this catalogue are only a reference and an illustration of the products finishing. The colours shown are not binding because brightness, contrast and colour balance may vary due to the printing process.
- Colours may vary due to raw-material suppliers' changes and some differences may occur in tonal range.
- Typical Indoor Comfort Standards state a temperature range of 20°C - 27°C (68°F - 81°F), and a relative humidity of less than 60%. These would be considered as normal operational levels of JOCAVI® products' range.
- Sizes may vary slightly due to their production method and some inherent raw-materials characteristics.





# REFLEX<sup>®</sup>

DIFFUSION PANEL

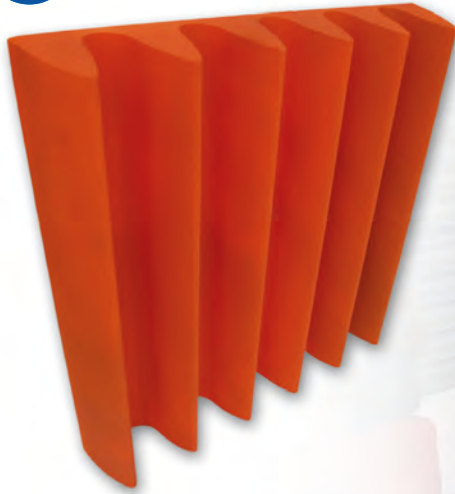

Image of 60x60cm model Ref.:RFL060 (on the left) and Ref.:RFL060 applied (ambient image).

## DESCRIPTION

The REFLEX<sup>®</sup> represents another option on acoustic diffusers, thus allowing different aesthetic and performance possibilities. It is made of high-quality 100% recyclable ecologic EPS raw material. It is used on side or back walls to blend the direct and early reflected sound, thus increasing speech intelligibility and enhancing musical clarity.

This diffusion panel offers optimal shape and more omnidirectional scattering diffusion than traditional, non-optimised panels do. It is a very good cost-effective choice for a 2D sound diffuser.

## TECHNICAL DRAWINGS

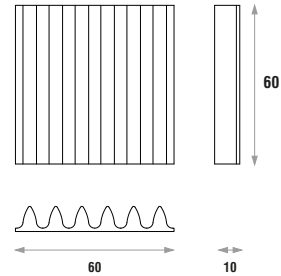

## FEATURES

- Average diffusion: **0.50/m<sup>2</sup>** [ $>100\text{Hz}; <5\text{KHz}$ ].
- NRC: **0.26/m<sup>2</sup>** [ $>100\text{Hz}; <5\text{KHz}$ ].
- Fire resistance: Euroclass B-s3,d1 (similar to old M1).
- Finished with an ecological paint.
- Very easy to install.
- Other colours available upon consultation.

## MODELS AND SIZES

MODELS	HEIGHT	WIDTH	DEPTH	WEIGHT
RFL060	60 cm	60 cm	10 cm	0.8 Kg

## DIFFUSION - ABSORPTION COEFFICIENT

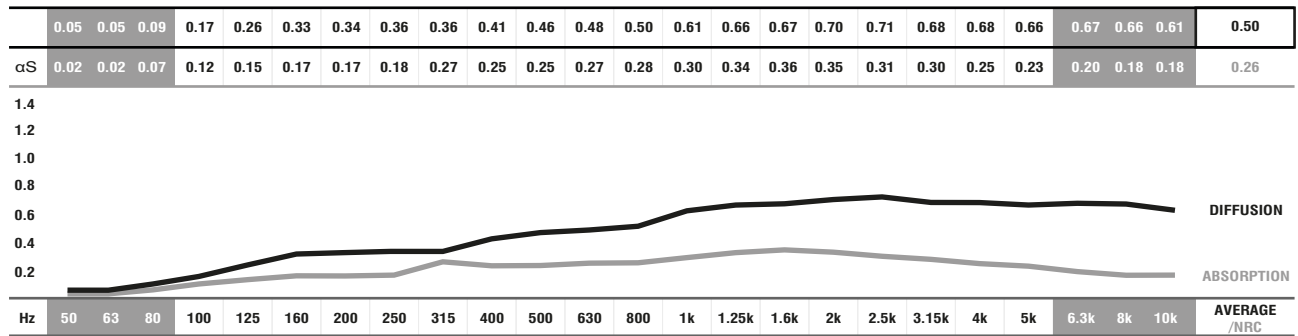

■ ABSORPTION COEFFICIENT: Values in accordance with the standards: EN 20654, ASTM C423 and EN 11654. ■ Values [ $<100\text{Hz}$  and  $>5\text{K}$ ] are Non Standard Values.  
 ■ DIFFUSION COEFFICIENT: These values were obtained by mathematical calculations and tests carried out in our laboratory.

## STANDARD EPS RAL COLOURS

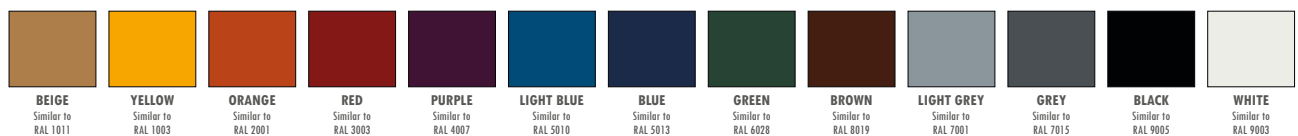

## IMPORTANT NOTICES

- JOCAVI<sup>®</sup> accepts no responsibility for any printing errors. Specifications can be modified without prior notice, if technical or commercial reasons so require.
- RAL<sup>®</sup> is an international independent colour standard system partner for industry, trade, architecture and design. Should be consulted before placing any order.
- The colours shown on this catalogue are only a reference and an illustration of the products finishing. The colours shown are not binding because brightness, contrast and colour balance may vary due to the printing process.
- Colours may vary due to raw-material suppliers' changes and some differences may occur in tonal range.
- Typical Indoor Comfort Standards state a temperature range of 20°C - 27°C (68°F - 81°F), and a relative humidity of less than 60%. These would be considered as normal operational levels of JOCAVI<sup>®</sup> products' range.
- Sizes may vary slightly due to their production method and some inherent raw-materials characteristics.



# COOKIE® ABSORBENT PANEL

CONVEX SHAPE

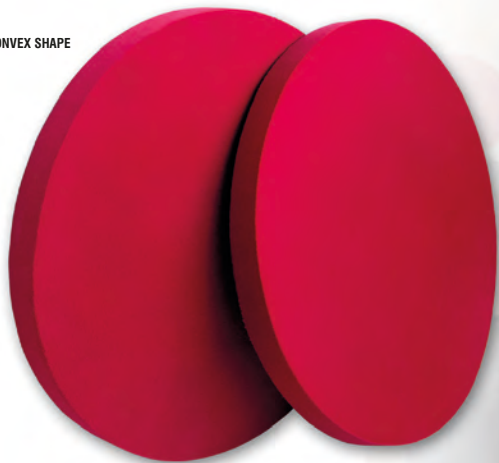

CONCAVE SHAPE

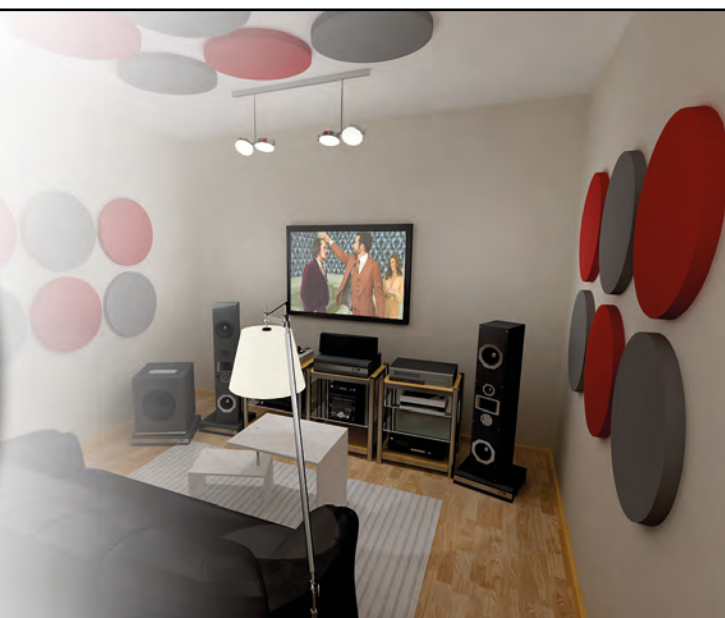

Image of 60x60cm pair models Ref.:COK060 (on the left) and the same applied (ambient image).

## DESCRIPTION

COOKIE® is made of a flexible open-cell regular foam which are excellent sound absorption materials. The optional velvet finishing gives this product an attractive luxury look. Its appearance describes a simple concave and convex circular shape and is always supplied in pairs.

COOKIE®'s acoustic characteristics make this product ideal for use as noise control device in buildings. It improves airborne noise reduction also providing fire safety and environmental requirements.

Due to its low weight, COOKIE® allows the creation of large-surface areas that can be glued or hanging, giving rooms an attractive appearance.

Meeting rooms, offices and hotel foyers can be acoustically upgraded just as effective and attractive by using this product. The installation method is very simple by using mounting glue.

The raw material of this product meets the most important international fire safety regulation. It is produced without using halogenated hydrocarbons, flame-retardants and/or toxic heavy metals.

## FEATURES

- NRC: **0.90/m²** [ $>250\text{Hz}$ ;  $<10\text{KHz}$ ].
- **ACOUSTIC FOAM** - Fire resistance: Euroclass B-s3,d1 (similar to old M1).
- Good thermal insulation properties and constant physical properties over a wide temperature range.
- Resistance to all organic solvents.
- Sold in pairs.
- Mounting: glue or by hanging.

## TECHNICAL DRAWINGS

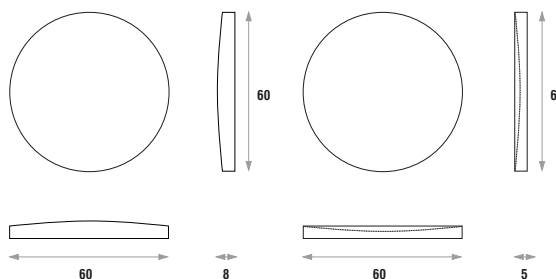

## MODELS AND SIZES

MODELS	HEIGHT	DIAMETER	WEIGHT
COK060	5/8 cm	60 cm	0.3 Kg
COK060v	5/8 cm	60 cm	0.3 Kg

## ABSORPTION COEFFICIENT\*

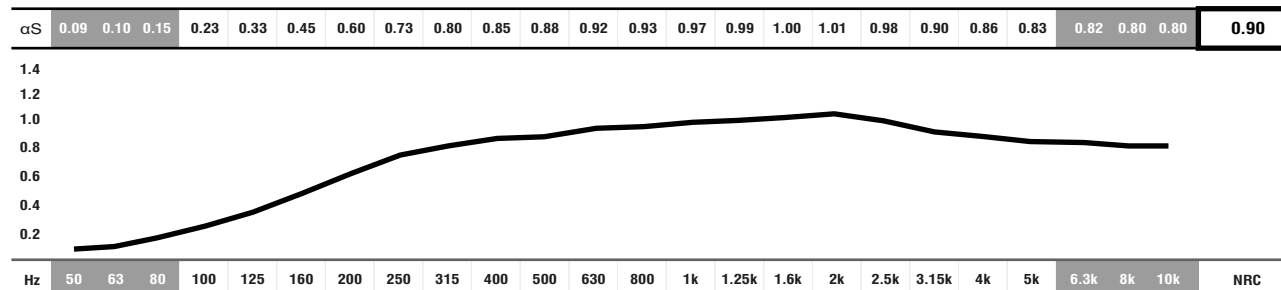

■ ABSORPTION COEFFICIENT: Values in accordance with the standards: EN 20654, ASTM C423 and EN 11654.

■ Values [ $<100\text{Hz}$  and  $>5\text{K}$ ] are Non Standard Values.  
\*PANEL DATA ONLY OF REF.: COK060 VELVETY FINISHING.

## REGULAR FOAM COLOURS

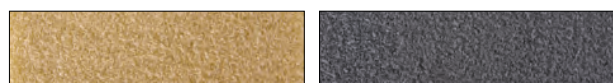

CREAM  
Regular Foam

GREY  
Regular Foam

## VELVETY COLOURS



RED

BLUE

GREY

BEIGE

BLACK

WHITE

## IMPORTANT NOTICES

- JOCAVI® accepts no responsibility for any printing errors. Specifications can be modified without prior notice, if technical or commercial reasons so require.
- The colours shown on this catalogue are only a reference and an illustration of the products finishing. The colours shown are not binding because brightness, contrast and colour balance may vary due to the printing process.
- Colours may vary due to raw-material suppliers' changes and some differences may occur in tonal range.
- Typical Indoor Comfort Standards state a temperature range of 20°C - 27°C (68°F - 81°F), and a relative humidity of less than 60%. These would be considered as normal operational levels of JOCAVI® products' range.
- Despite all the standard sizes of all products, this model can be customised upon previous consultation. Sizes may vary slightly due to their production method and some inherent raw-materials characteristics.





**CAMOU®**  
ABSORBENT PANEL



Image of 60x60cm model Ref.:CAM060 (on the left) and Ref.:CAM060 applied (ambient image).

## DESCRIPTION

This panel is an updated version of the COSMOS® panel, but is distinct from it. It is an absorbent panel, in particular of the mid-range of the sound spectrum, and is meant to be mounted on walls and ceilings. This model has a fabric-coated front part and a support structure that gives it more mass and enables, therefore, quite different acoustic performances.

The CAMOU® may be used in any type of rooms to reduce airborne noise. It is particularly efficient in rooms where the aesthetic factor is more neutral. This panel can be glued directly on walls and ceilings. Mounting stripes are available for removable mounting. All installation accessories are sold separately. It can be installed by coupling several pieces that form a very absorbent surface with outstanding results. Its size makes it one of the best available options in the market. The back part is a white EPS solid box which can be painted on request with our EPS available colours. The box interior's acoustic labyrinth is filled with recycled acoustic material.

## FEATURES

- Fabric-coated acoustic regular foam on a rigid framework.
- NRC: **0.84/m²** [>100Hz; <5KHz].
- Fire-resistance: Fabric - Euroclass B (similar to old M1); EPS - Euroclass B-s3,d1 (similar to old M1).
- Several colours.
- Installation: easy to install.

## TECHNICAL DRAWINGS

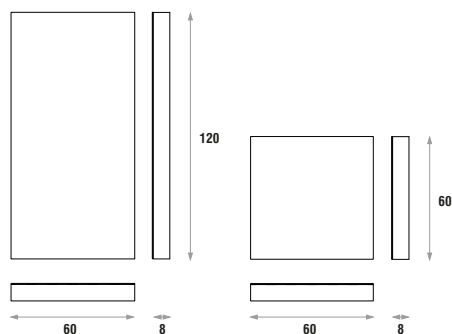

## MODELS AND SIZES

MODELS	HEIGHT	WIDTH	DEPTH	WEIGHT
CAM120	120cm	60 cm	8 cm	3.4 Kg
CAM060	60 cm	60 cm	8 cm	1.7 Kg

## ABSORPTION COEFFICIENT

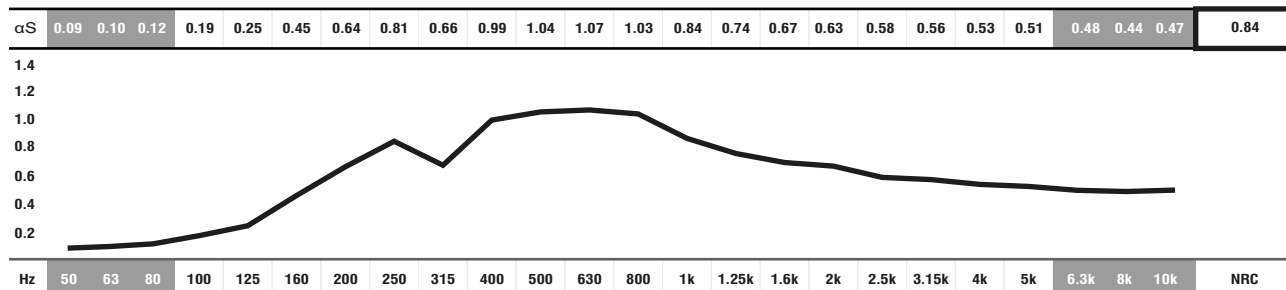

■ ABSORPTION COEFFICIENT: Values in accordance with the standards: EN 20654, ASTM C423 and EN 11654.

■ Values [<100Hz and > 5K] are Non Standard Values.

## STANDARD FABRIC COLOURS

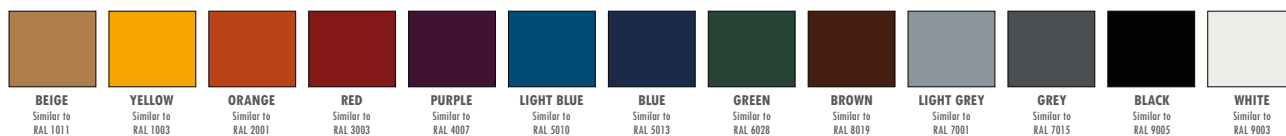

## IMPORTANT NOTICES

- JOCAVI® accepts no responsibility for any printing errors. Specifications can be modified without prior notice, if technical or commercial reasons so require.
- RAL® is an international independent colour standard system partner for industry, trade, architecture and design. Should be consulted before placing any order.
- The colours shown on this catalogue are only a reference and an illustration of the products finishing. The colours shown are not binding because brightness, contrast and colour balance may vary due to the printing process.
- Colours may vary due to raw-material suppliers' changes and some differences may occur in tonal range.
- Typical Indoor Comfort Standards state a temperature range of 20°C - 27°C (68°F - 81°F), and a relative humidity of less than 60%. These would be considered as normal operational levels of JOCAVI® products' range.
- Sizes may vary slightly due to their production method and some inherent raw-materials characteristics.







# COSMOS<sup>®</sup> ABSORBENT PANEL

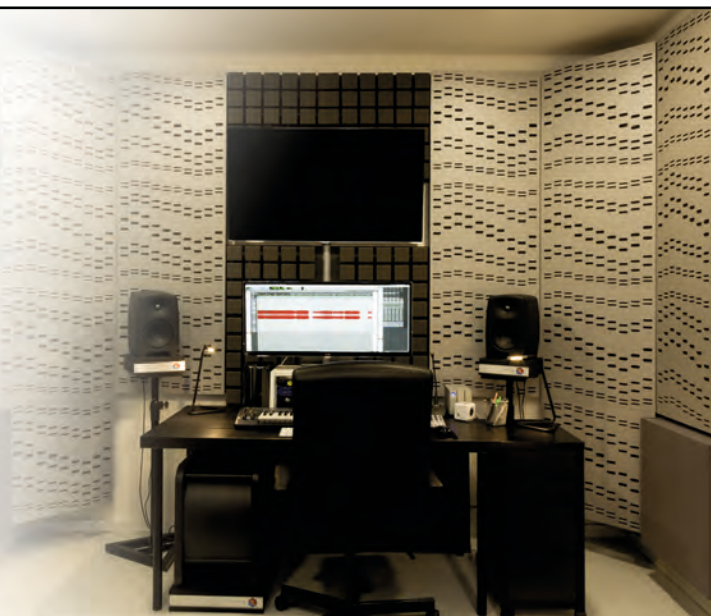

Image of 60x60cm model Ref.:COS060 (on the left) and Ref.:COS060 applied (ambient image).

## DESCRIPTION

The COSMOS<sup>®</sup> is an acoustic panel with a set of four different aesthetics that meet all kinds of requirements. It is an acoustic solution for commercial areas, offices, public spaces, as well as audio and video studios.

Acoustic designers usually favour this type of covering because it is efficient and has a refined finishing as well. These are inexpensive and very attractive proposals.

The 8cm thickness and the inside labyrinth provide COSMOS<sup>®</sup> with a high absorption coefficient.

This absorbent panel comprises the full spectrum of the human voice and is used to absorb slap and flutter echoes in the room, thus allowing a more pleasant and accurate listening environment.

This model proposes four different perforations and five synthetic-wood finishes, as well as a flexible design with coupling options for the several pieces, therefore enabling different and varied aesthetic combinations.

## TECHNICAL DRAWINGS

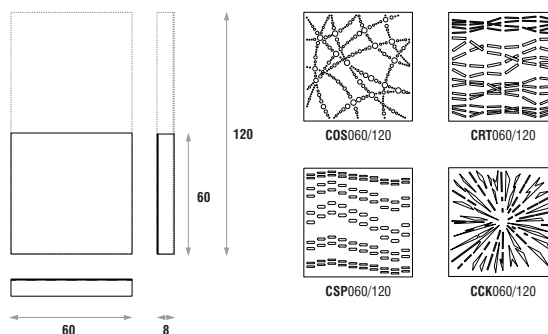

## FEATURES

- Rigid melamine faced board framework on a HD EPS box.
- NRC: **0.79/m<sup>2</sup>**(COSMOS), **0.88/m<sup>2</sup>**(SP), **0.89/m<sup>2</sup>**(RT), **0.80/m<sup>2</sup>**(CK)[>250Hz;<1KHz].
- Fire-resistance: Melamine Faced Board - Euroclass B-s2,d0 (similar to old M1); EPS - Euroclass B-s3,d1 (similar to old M1).
- Very easy to install.

## MODELS AND SIZES

MODELS	HEIGHT	WIDTH	DEPTH	WEIGHT
COS120	120 cm	60 cm	8 cm	3.4 Kg
COS060	60 cm	60 cm	8 cm	1.7 Kg

## ABSORPTION COEFFICIENT

αS	010	011	014	016	028	043	058	077	092	1.06	1.10	1.05	0.95	0.74	0.66	0.59	0.55	0.51	0.46	0.42	0.39	0.39	0.37	0.36	<b>0.79</b>
αS	0.09	0.10	0.12	0.19	0.31	0.44	0.57	0.76	0.93	0.98	1.04	1.09	1.12	1.08	0.92	0.77	0.63	0.48	0.47	0.45	0.44	0.43	0.42	0.42	<b>0.88</b>
αS	0.11	0.12	0.16	0.18	0.29	0.41	0.54	0.74	0.90	1.02	1.04	1.06	1.10	1.11	1.08	0.84	0.62	0.52	0.47	0.42	0.38	0.36	0.36	0.35	<b>0.89</b>
αS	0.10	0.11	0.15	0.16	0.26	0.40	0.54	0.73	0.87	0.93	0.97	1.00	1.01	0.98	0.73	0.61	0.52	0.47	0.43	0.41	0.34	0.33	0.33	0.32	<b>0.80</b>

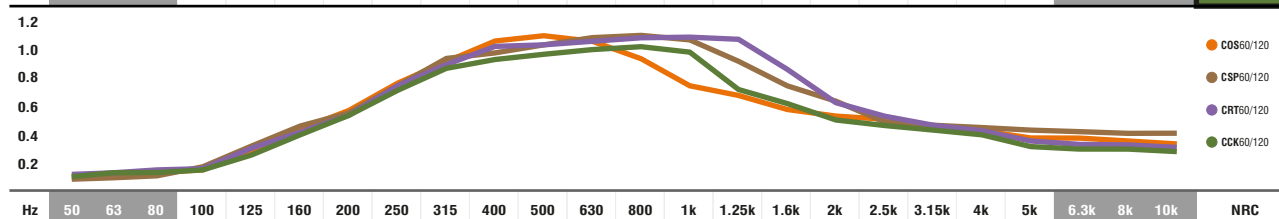

● ● ● ● ABSORPTION COEFFICIENT: Values in accordance with the standards: EN 20654, ASTM C423 and EN 11654. ■ Values [ $<100\text{Hz}$  and  $>5\text{K}$ ] are Non Standard Values.

## MELAMINE FACED BOARD FINISHINGS



## IMPORTANT NOTICES

- JOCAVI<sup>®</sup> accepts no responsibility for any printing errors. Specifications can be modified without prior notice, if technical or commercial reasons so require.
- The colours shown on this catalogue are only a reference and an illustration of the products finishing. The colours shown are not binding because brightness, contrast and colour balance may vary due to the printing process.
- Colours may vary due to raw-material suppliers' changes and some differences may occur in total range.
- Due to its natural origin, wood-based products will always present natural imperfections inherent to the organic nature. And for similar reasons, they will also present traces of old-age in the course of time.
- Wood and Fabric products are highly susceptible to change its appearance with humidity and temperature. Close attention must be paid to the storage conditions and the acclimatization before, during and after the installation.
- Typical Indoor Comfort Standards state a temperature range of 20°C - 27°C (68°F - 81°F), and a relative humidity of less than 60%. These would be considered as normal operational levels of JOCAVI<sup>®</sup> products' range.
- Despite all the standard sizes of all products, this model can be customised upon previous consultation. Sizes may vary slightly due to their production method and some inherent raw-materials characteristics.



# CUBESORB®

ABSORBENT PANEL

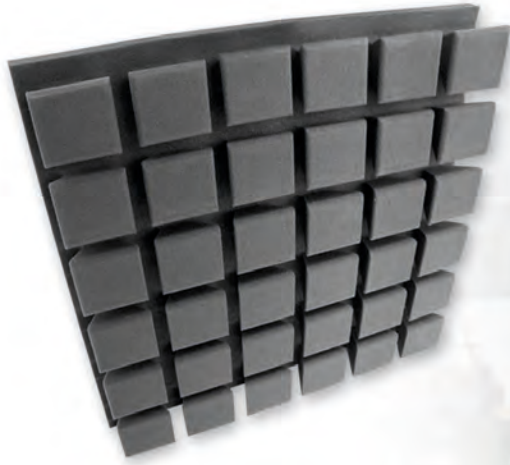

Image of 60x60cm model Ref.:CUS060 (on the left) and Ref.:CUS060 applied (ambient image).

## DESCRIPTION

The CUBESORB® is one of the least expensive and most popular quadratic shaped acoustic treatment absorbers made of acoustic foam. It is recommended for project spaces, vocal booths, control rooms and sound studios. The CUBESORB® is used to treat small to medium-sized rooms.

You can also use it on industry market solutions when mandatory and stronger acoustic absorption is required. Its protruding cubes form some concave grooves which cause a substantial increase of the absorption coefficient. They effectively reduce stationary waves and flutter echoes.

When used in combination with the CUBEFUSER®, the resulting scattering sound balances diffusion inside your room. Fix your room acoustics without the help of a professional.

## TECHNICAL DRAWINGS

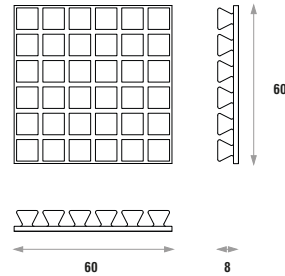

## FEATURES

- Raw material: Melamine Foam or Regular Acoustic Foam.
- NRC: **0.79/m²** [ $>250\text{Hz}; <10\text{KHz}$ ].
- **MELAMINE FOAM** - Flame resistance: Euroclass B-s1,d0 (similar to old M1 France, Germany B1,GB class1, USA V0/HF1).
- **ACOUSTIC FOAM** - Flame resistance: Euroclass B-s3,d1 (similar to old M1).
- Installation: glue or mount on "T-ceiling".
- Very easy to install.

## MODELS AND SIZES

MODELS	HEIGHT	WIDTH	DEPTH	WEIGHT
CUS060	60 cm	60 cm	8 cm	0.3 Kg
CUS060TC	60 cm	60 cm	8 cm	0.5 Kg

## ABSORPTION COEFFICIENT

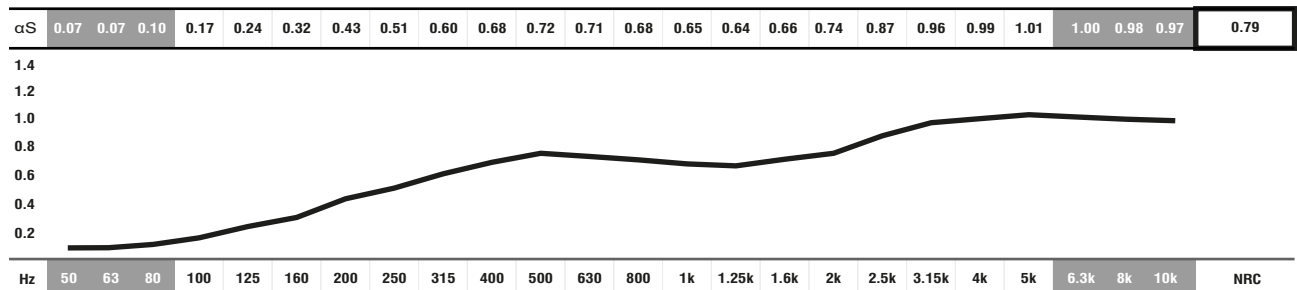

■ ABSORPTION COEFFICIENT: Values in accordance with the standards: EN 20654, ASTM C423 and EN 11654.

■ Values [ $<100\text{Hz}$  and  $>5\text{K}$ ] are Non Standard Values.

## REGULAR AND MELAMINE FOAM COLOURS



CREAM  
Regular Foam



GREY  
Regular Foam



LIGHT GREY  
Melamine Foam



WHITE  
Melamine Foam

## IMPORTANT NOTICES

- JOCAVI® accepts no responsibility for any printing errors. Specifications can be modified without prior notice, if technical or commercial reasons so require.
- The colours shown on this catalogue are only a reference and an illustration of the products finishing. The colours shown are not binding because brightness, contrast and colour balance may vary due to the printing process.
- Colours may vary due to raw-material suppliers' changes and some differences may occur in tonal range. Close attention must be paid to the storage conditions and the acclimatization before, during and after the installation.
- Typical Indoor Comfort Standards state a temperature range of 20°C - 27°C (68°F - 81°F), and a relative humidity of less than 60%. These would be considered as normal operational levels of JOCAVI® products' range.
- Despite all the standard sizes of all products, this model can be customised upon previous consultation. Sizes may vary slightly due to their production method and some inherent raw-materials characteristics.



# CUBESORB ARC<sup>®</sup>

ABSORBENT PANEL

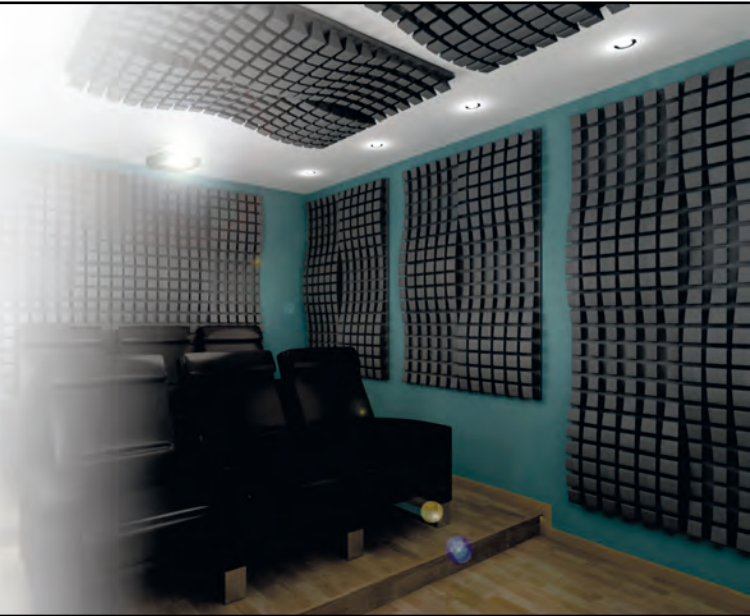

Image of pair of the 60x60cm model Ref.:CUB060A (on the left) and Ref.:CUB060A (pair) applied (ambient image).

## DESCRIPTION

The CUBESORB ARC<sup>®</sup> is a quadratic-shaped acoustic treatment absorber made of self-extinguishing acoustic foam. Its geometry describes several quadrilateral and rectangular modules with different heights. When viewed from an angled perspective, the shape describes concave and convex arcs that wave uniformly, thus allowing an attractive geometric design. The CUBESORB ARC<sup>®</sup> can also be combined with the similar CUBESORB<sup>®</sup> and/or CUBEFUSER<sup>®</sup>, which has a flat appearance.

The CUBESORB ARC<sup>®</sup> is recommended for project spaces, large room environments, common workspaces, music studios and vocal booths.

This product is installed by gluing it directly to the existing surface with our recommended adhesives. It can also be used in areas that have "T-ceiling", when mandatory and stronger acoustic absorption is required. Its protruding cubes form some concave grooves, which cause a substantial increase of the absorption coefficient, thus reducing standing waves and flutter echoes for better sound intelligibility.

It is a very efficient absorbent panel meant for budget-conscious acoustic projects.

## FEATURES

- Raw material: Melamine Foam or Regular Acoustic Foam.
- NRC: 0.79/m<sup>2</sup> (>250Hz; <10KHz).
- **MELAMINE FOAM** - Flame resistance: Euroclass B-s1,d0 (similar to old M1 France, Germany B1,GB class1, USA V0/HF1).
- **ACOUSTIC FOAM** - Flame resistance: Euroclass B-s3,d1 (similar to old M1).
- Standard Dimensions: 60x60x11cm.
- Installation: glue or mount on "T-ceiling".
- Sold in pairs.

## TECHNICAL DRAWINGS

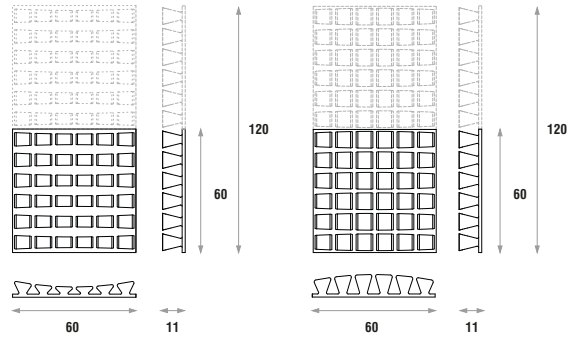

## MODELS AND SIZES

MODELS	HEIGHT	WIDTH	DEPTH	WEIGHT
CUB120A	120cm	60 cm	5/11 cm	0.8 Kg
CUB060A	60 cm	60 cm	5/11 cm	0.4 Kg
CUB060Atc	60 cm	60 cm	5/11 cm	0.5 Kg

## ABSORPTION COEFFICIENT

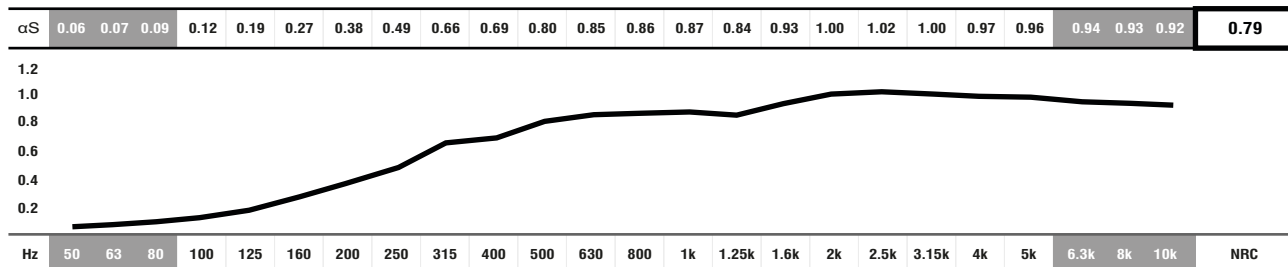

■ ABSORPTION COEFFICIENT: Values in accordance with the standards: EN 20654, ASTM C423 and EN 11654.

■ Values [<100Hz and > 5K] are Non Standard Values.

## REGULAR AND MELAMINE FOAM COLOURS



CREAM  
Regular Foam



GREY  
Regular Foam



LIGHT GREY  
Melamine Foam



WHITE  
Melamine Foam

## IMPORTANT NOTICES

- JOCAVI<sup>®</sup> accepts no responsibility for any printing errors. Specifications can be modified without prior notice, if technical or commercial reasons so require.
- The colours shown on this catalogue are only a reference and an illustration of the products finishing. The colours shown are not binding because brightness, contrast and colour balance may vary due to the printing process.
- Colours may vary due to raw-material suppliers' changes and some differences may occur in tonal range. Close attention must be paid to the storage conditions and the acclimatization before, during and after the installation.
- Typical Indoor Comfort Standards state a temperature range of 20°C - 27°C (68°F - 81°F), and a relative humidity of less than 60%. These would be considered as normal operational levels of JOCAVI<sup>®</sup> products' range.
- Despite all the standard sizes of all products, this model can be customised upon previous consultation. Sizes may vary slightly due to their production method and some inherent raw-materials characteristics.







# FOAMSORB® /INVERTED

ABSORBENT PANEL

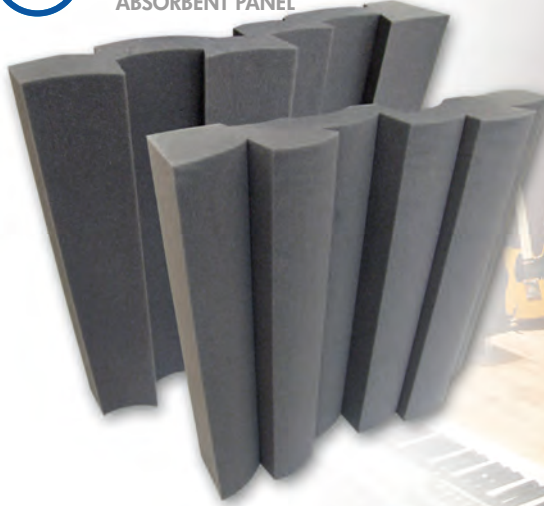

Image of 60x60cm models Ref.:FS0060 and Ref.:FSI060 (on the left) and Ref.:FS0060 and Ref.:FSI060 applied (ambient image).

## DESCRIPTION

The FOAMSORB INV® absorption panels are ATP® registered products and the real mid-range absorbers from our collection. They are made of high-quality controlled-cell, self-extinguishable M1 fire-retardant acoustic foam.

The FOAMSORB INV® panels present a unique and elegant design; the male and female pieces help solve many of the rooms' acoustic anomalies.

These panels have a high absorption coefficient in the broad range of the sound spectrum, and are significantly efficient at absorbing medium-low frequencies.

In general terms, they work well on flat walls and ceilings. They can be combined with the WAVYFUSER INV® diffusion panels, which have the same shape, thus giving music rooms a truly balanced continuous acoustic treatment surface and a fine-looking design.

## TECHNICAL DRAWINGS

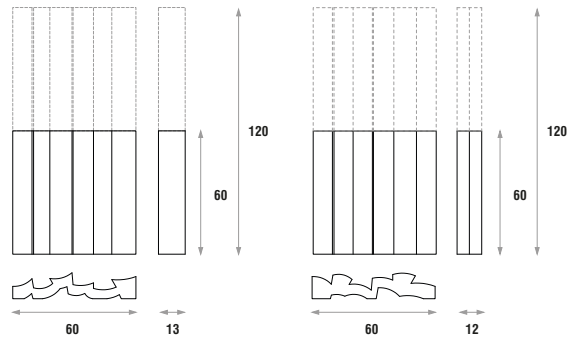

## FEATURES

- Raw material: Melamine Foam or Regular Acoustic Foam.
- NRC: **0.95/m²** [ $>250\text{Hz}; <10\text{KHz}$ ].
- **MELAMINE FOAM** - Flame resistance: Euroclass B-s1,d0 (similar to old M1 France, Germany B1,GB class1, USA V0/HF1).
- **ACOUSTIC FOAM** - Flame resistance: Euroclass B-s3,d1 (similar to old M1).
- Great decorative alternatives.
- Sold in pairs.

## MODELS AND SIZES

MODELS	HEIGHT	WIDTH	DEPTH	WEIGHT
FS0/120	120 cm	60 cm	13/12 cm	1.2 Kg
FS0/060	60 cm	60 cm	13/12 cm	0.6 Kg

SOLD IN PAIRS

## ABSORPTION COEFFICIENT

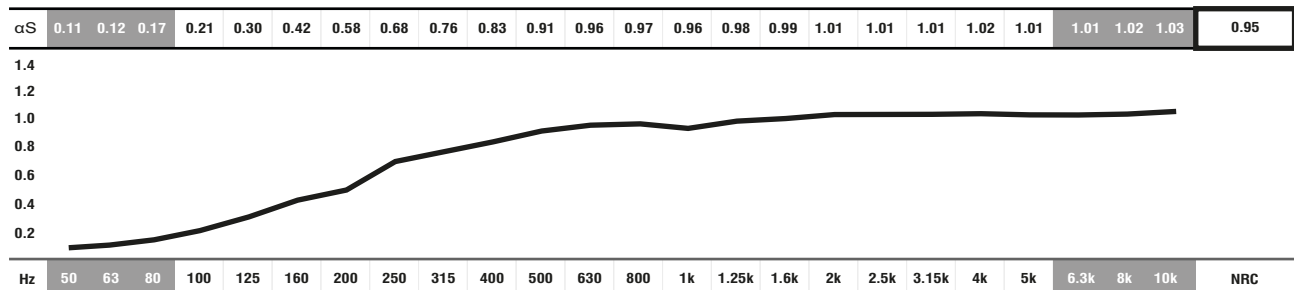

■ ABSORPTION COEFFICIENT: Values in accordance with the standards: EN 20654, ASTM C423 and EN 11654.

■ Values [ $<100\text{Hz}$  and  $>5\text{K}$ ] are Non Standard Values.

## REGULAR AND MELAMINE FOAM COLOURS



CREAM  
Regular Foam



GREY  
Regular Foam



LIGHT GREY  
Melamine Foam



WHITE  
Melamine Foam

## IMPORTANT NOTICES

- JOCAVI® accepts no responsibility for any printing errors. Specifications can be modified without prior notice, if technical or commercial reasons so require.
- The colours shown on this catalogue are only a reference and an illustration of the products finishing. The colours shown are not binding because brightness, contrast and colour balance may vary due to the printing process.
- Colours may vary due to raw-material suppliers' changes and some differences may occur in tonal range. Close attention must be paid to the storage conditions and the acclimatization before, during and after the installation.
- Typical Indoor Comfort Standards state a temperature range of 20°C - 27°C (68°F - 81°F), and a relative humidity of less than 60%. These would be considered as normal operational levels of JOCAVI® products' range.
- Despite all the standard sizes of all products, this model can be customised upon previous consultation. Sizes may vary slightly due to their production method and some inherent raw-materials characteristics.





# AB TWICE® ABSORBENT PANEL

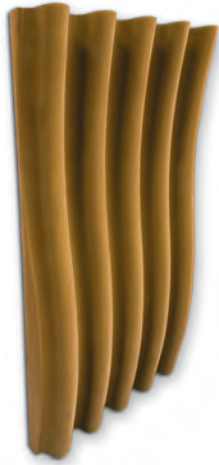

Image of 120x60cm model Ref.:ABT120 (on the left) and Ref.:ABT120 applied (ambient image).

## DESCRIPTION

The AB Twice® is an acoustic treatment absorber made of self-extinguishing acoustic foam. Each model has an angular arc-shaped geometry that describes five mountains within a concept of three-dimensional geometry.

The finish of this model is of the utmost quality. Its soft finish layer improves its acoustic performance and provides a fine and "smooth like velvet" appearance. The velvet finish gives this product a distinctive feeling of comfort.

A combination of several modules makes this acoustic solution very attractive with a harmonised look.

The creation of surfaces that are efficient at absorbing sound waves becomes imperative, and that is the main feature that makes this product so relevant. This panel is meant to absorb mid-low to high range frequencies.

The AB Twice® is perfect to cover continuous areas of walls or ceilings as a coating material and can be used as a soundproofing reinforcement as well.

It is ideal for commercial areas, television studios, pavilions, auditoriums, meeting rooms, public spaces, etc., that need specific care regarding airborne noise control.

## FEATURES

- **FINISHINGS AVAILABLE:** Regular Foam or the Velvety Finishing.
- **NRC: 0.87/m²** (>250Hz; <10KHz).
- **ACOUSTIC FOAM** - Flame resistance: Euroclass B-s3,d1 (similar to old M1).
- Shape and design recommended for continuous surface treatment.
- Very easy to install.
- Standard Dimensions: 120x60x11cm.
- Sold in pairs.

## TECHNICAL DRAWINGS

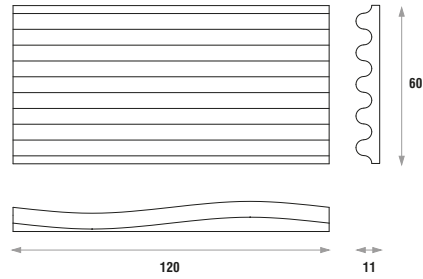

## MODELS AND SIZES

MODELS	HEIGHT	WIDTH	DEPTH	WEIGHT
ABT120	120cm	60 cm	5/11 cm	0.8 Kg

SOLD IN PAIRS

## ABSORPTION COEFFICIENT

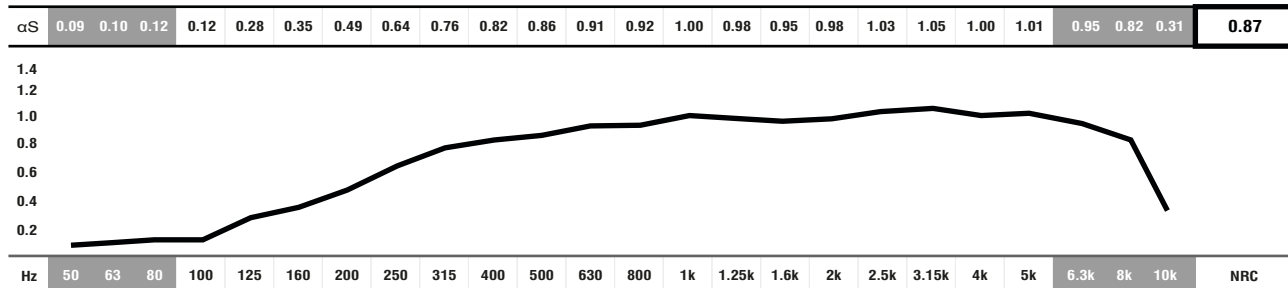

■ ABSORPTION COEFFICIENT: Values in accordance with the standards: EN 20654, ASTM C423 and EN 11654.

■ Values [<100Hz and > 5K] are Non Standard Values.

## REGULAR FOAM COLOURS

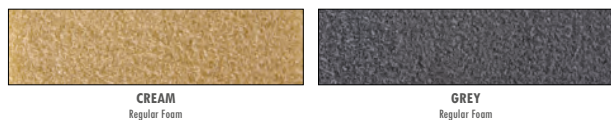

## VELVETY COLOURS



## IMPORTANT NOTICES

- JOCAVI® accepts no responsibility for any printing errors. Specifications can be modified without prior notice, if technical or commercial reasons so require.
- The colours shown on this catalogue are only a reference and an illustration of the products finishing. The colours shown are not binding because brightness, contrast and colour balance may vary due to the printing process.
- Colours may vary due to raw-material suppliers' changes and some differences may occur in tonal range.
- Typical Indoor Comfort Standards state a temperature range of 20°C - 27°C (68°F - 81°F), and a relative humidity of less than 60%. These would be considered as normal operational levels of JOCAVI® products' range.
- Despite all the standard sizes of all products, this model can be customised upon previous consultation. Sizes may vary slightly due to their production method and some inherent raw-materials characteristics.





# STRIPESORB®

ABSORBENT PANEL

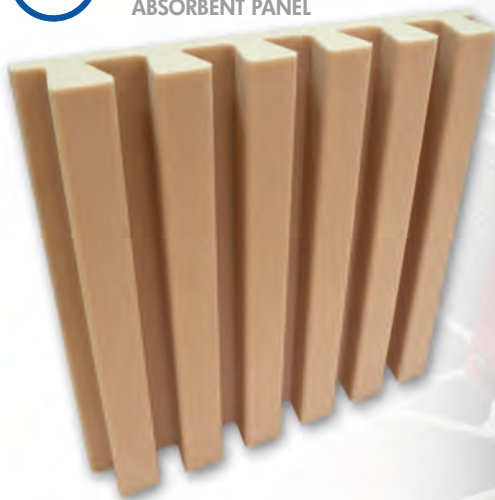

Image of 60x60cm model Ref.:STS060 (on the left) and Ref.:STS120 applied (ambient image).

## DESCRIPTION

The STRIPESORB® is the panel meant for budget-conscious acoustic projects. The STRIPESORB® acoustic foam panels are cut in a simple standard method to keep them more affordable. It is a great solution to treat acoustics in small sound studios, home listening rooms and small vocal or instrument booths, by solving small flutter echo problems.

Its shape maximises the area that is exposed to the sound waves for better absorption. You can combine the STRIPESORB® with the STRIPEFUSER® diffusion panel. They have the same shape and offer great decorative alternatives.

## TECHNICAL DRAWINGS

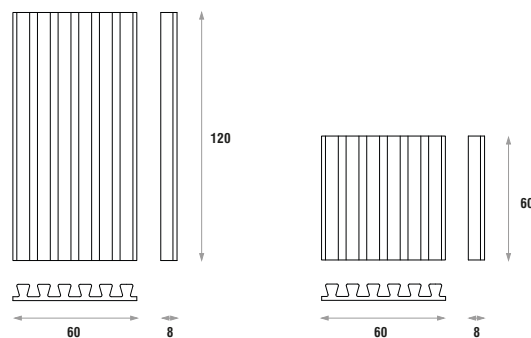

## FEATURES

- Raw material: Melamine Foam or Regular Acoustic Foam.
- NRC: **0.81/m²** [ $>250\text{Hz}; <10\text{KHz}$ ].
- **MELAMINE FOAM** - Flame resistance: Euroclass B-s1,d0 (similar to old M1 France, Germany B1,GB class1, USA VO/HF1).
- **ACOUSTIC FOAM** - Flame resistance: Euroclass B-s3,d1 (similar to old M1).
- Very easy to install.

## MODELS AND SIZES

MODELS	HEIGHT	WIDTH	DEPTH	WEIGHT
STS120	120cm	60 cm	8 cm	0.8 Kg
STS060	60 cm	60 cm	8 cm	0.4 Kg

## ABSORPTION COEFFICIENT

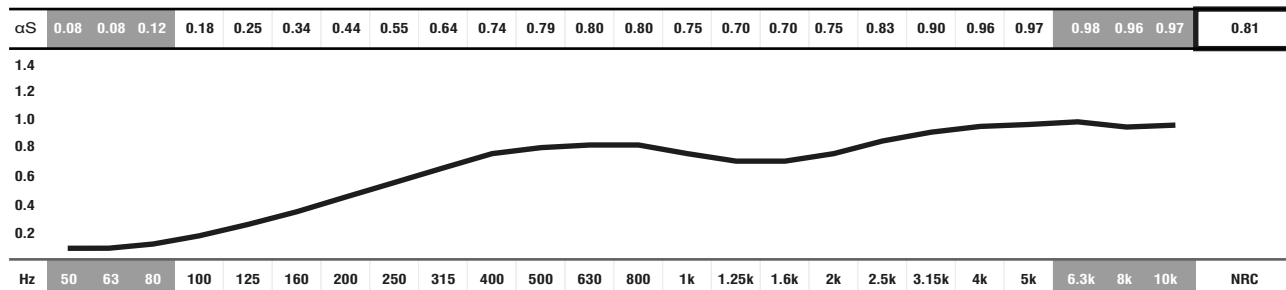

■ ABSORPTION COEFFICIENT: Values in accordance with the standards: EN 20654, ASTM C423 and EN 11654.

■ Values [ $<100\text{Hz}$  and  $>5\text{K}$ ] are Non Standard Values.

## REGULAR AND MELAMINE FOAM COLOURS



CREAM  
Regular Foam



GREY  
Regular Foam



LIGHT GREY  
Melamine Foam

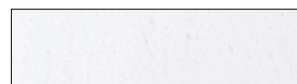

WHITE  
Melamine Foam

## IMPORTANT NOTICES

- JOCAVI® accepts no responsibility for any printing errors. Specifications can be modified without prior notice, if technical or commercial reasons so require.
- The colours shown on this catalogue are only a reference and an illustration of the products finishing. The colours shown are not binding because brightness, contrast and colour balance may vary due to the printing process.
- Colours may vary due to raw-material suppliers' changes and some differences may occur in tonal range. Close attention must be paid to the storage conditions and the acclimatization before, during and after the installation.
- Typical Indoor Comfort Standards state a temperature range of 20°C - 27°C (68°F - 81°F), and a relative humidity of less than 60%. These would be considered as normal operational levels of JOCAVI® products' range.
- Despite all the standard sizes of all products, this model can be customised upon previous consultation. Sizes may vary slightly due to their production method and some inherent raw-materials characteristics.







# STRIPESORB ARC®

ABSORBENT PANEL



Image of pair of the 60x60cm model Ref.:STS060A (on the left) and Ref.:STS120A applied (ambient image).

## DESCRIPTION

The STRIPESORB ARC® is a stripe-shaped acoustic treatment absorber made of self-extinguishing acoustic foam.

Its shape looks similar to parallel blades with angular spaces between them. It was achieved in order to have small longitudinal absorption surfaces separated by small angled incisions meant to enhance absorption.

By combining several identical modules, the shape looks like concave and convex arcs that wave uniformly, which results in an attractive geometric look. The STRIPESORB ARC® can also be combined with the similar STRIPESORB®, which has a flat appearance.

The STRIPESORB ARC® acoustic foam panel is cut in a simple standard method to keep it more affordable. It is recommended for project spaces, large room environments, common workspaces, music studios, listening rooms, as well as small booths. This model can be applied on large continuous ceiling areas when mandatory and stronger acoustic absorption is required, by solving small flutter echo problems. Its shape maximises the area that is exposed to sound waves for better absorption.

The STRIPESORB ARC® is installed by gluing it directly to the existing surface with our recommended adhesives.

## FEATURES

- Raw material: Melamine Foam or Regular Acoustic Foam.
- NRC: **0.81/m<sup>2</sup>** (>250Hz; <10KHz).
- **MELAMINE FOAM** - Flame resistance: Euroclass B-s1,d0 (similar to old M1 France, Germany B1,GB class1, USA V0/HF1).
- **ACOUSTIC FOAM** - Flame resistance: Euroclass B-s3,d1 (similar to old M1).
- Standard Dimensions: 60x60x11cm and 120x60x11cm.
- Shape and design recommended for continuous surface treatment.
- Sold in pairs.

## TECHNICAL DRAWINGS

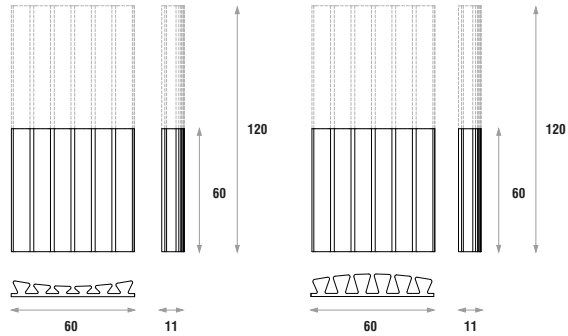

## MODELS AND SIZES

MODELS	HEIGHT	WIDTH	DEPTH	WEIGHT
STS120A	120cm	60 cm	11/5 cm	0.8 Kg
STS060A	60 cm	60 cm	11/5 cm	0.4 Kg

## ABSORPTION COEFFICIENT

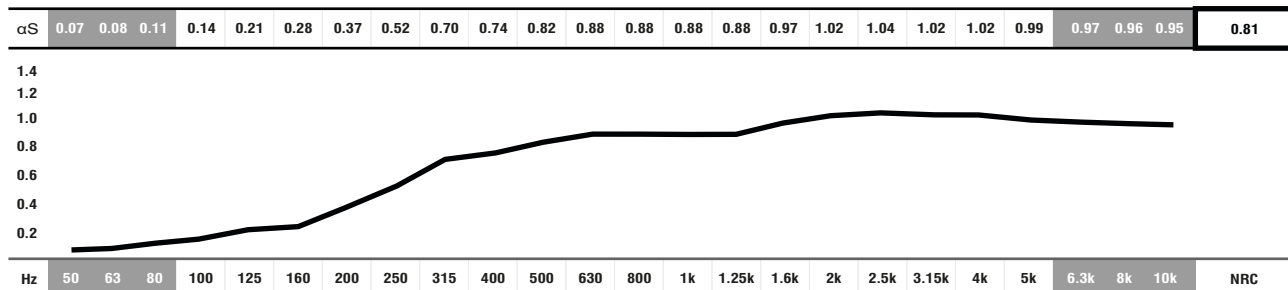

■ ABSORPTION COEFFICIENT: Values in accordance with the standards: EN 20654, ASTM C423 and EN 11654.

■ Values [<100Hz and > 5K] are Non Standard Values.

## REGULAR AND MELAMINE FOAM COLOURS

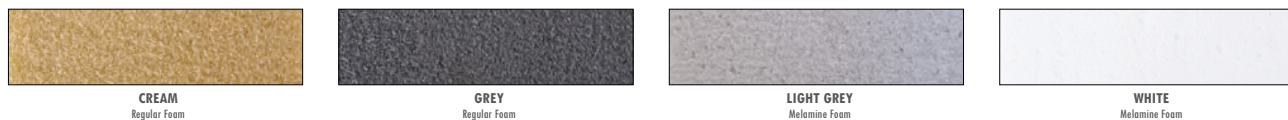

## IMPORTANT NOTICES

- JOCAVI® accepts no responsibility for any printing errors. Specifications can be modified without prior notice, if technical or commercial reasons so require.
- The colours shown on this catalogue are only a reference and an illustration of the products finishing. The colours shown are not binding because brightness, contrast and colour balance may vary due to the printing process.
- Colours may vary due to raw-material suppliers' changes and some differences may occur in tonal range. Close attention must be paid to the storage conditions and the acclimatization before, during and after the installation.
- Typical Indoor Comfort Standards state a temperature range of 20°C - 27°C (68°F - 81°F), and a relative humidity of less than 60%. These would be considered as normal operational levels of JOCAVI® products' range.
- Despite all the standard sizes of all products, this model can be customised upon previous consultation. Sizes may vary slightly due to their production method and some inherent raw-materials characteristics.





# SEAFOAM<sup>®</sup>

ABSORBENT PANEL

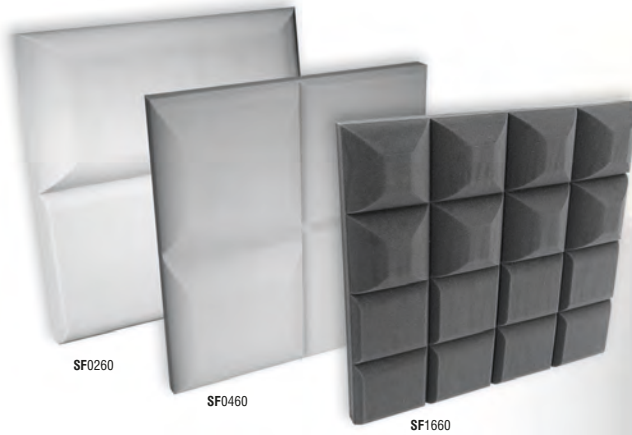

Image of 60x60cm models Ref.:SF0260, Ref.:SF0460 and Ref.:SF1660 (on the left) and Ref.:SF0260 Velvety Finishing applied (ambient image).

## DESCRIPTION

The SEAFOAM<sup>®</sup> is made of a flexible open-cell foam from melamine resin, a thermoset polymer. This foam is characterised by its three-dimensional network structure which consists of easily shaped thin filaments. The sound waves penetrate the open-cell structure, thus reducing the reflected energy and giving this product an excellent sound absorption capacity.

Due to its low weight, the SEAFOAM<sup>®</sup> allows the creation of large-surface elements that seem to be free-floating, giving rooms an attractive appearance. The simple installation method does not require any additional structural or engineering calculations. Working areas which are exposed to high levels of noise, such as industrial areas, pavilions, among others, can be acoustically restored at a low cost, by reequipping them with these lightweight absorbers. We can make specific shapes and sizes for large projects upon demand. The SEAFOAM<sup>®</sup>'s acoustic and safety characteristics make this product ideal for use as a noise control and sound insulation device in buildings that have demanding requirements against fire. It improves acoustics and soundproofing, thereby providing safety in accordance with environmental standards.

## FEATURES

- Raw material: Melamine Foam or Regular Acoustic Foam.
- NRC: **0.80/m<sup>2</sup>**.
- **MELAMINE FOAM** - Flame resistance: Euroclass B-s1,d0 (similar to old M1 France, Germany B1,GB class1, USA VO/HF1).
- **ACOUSTIC FOAM** - Flame resistance: Euroclass B-s3,d1 (similar to old M1).
- Velvety Finishing available.
- Very easy to install.
- 100% recyclable.

## TECHNICAL DRAWINGS

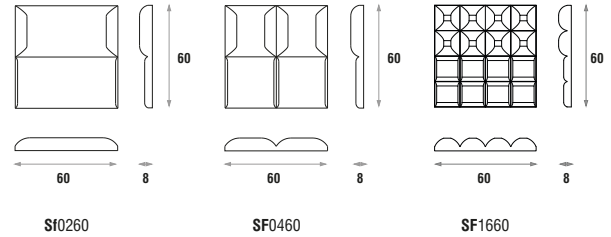

## MODELS AND SIZES

MODELS	HEIGHT	WIDTH	DEPTH	WEIGHT
SF0260	60 cm	60 cm	8 cm	0.60 Kg
SF0460	60 cm	60 cm	8 cm	0.60 Kg
SF1660	60 cm	60 cm	8 cm	0.60 Kg

## ABSORPTION COEFFICIENT\*

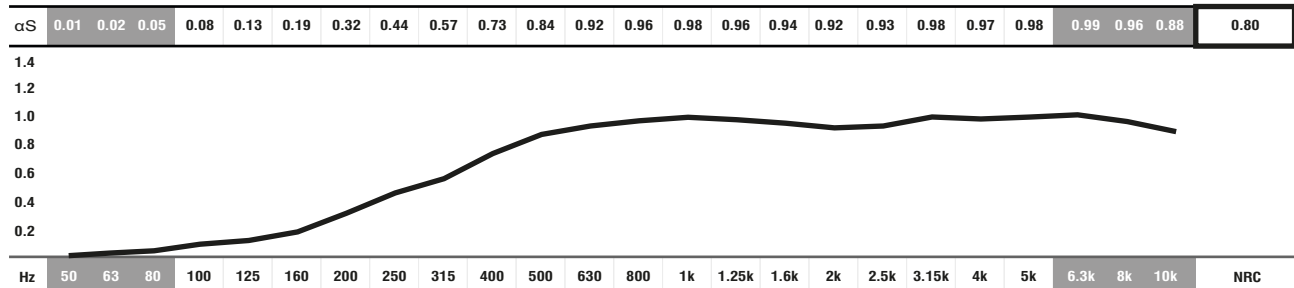

■ ABSORPTION COEFFICIENT: Values in accordance with the standards: EN 20654, ASTM C423 and EN 11654.

■ Values [ $< 100\text{Hz}$  and  $> 5\text{K}$ ] are Non Standard Values.

\*PANEL DATA ONLY OF REF: SF0460 REGULAR FOAM.

## REGULAR AND MELAMINE FOAM COLOURS

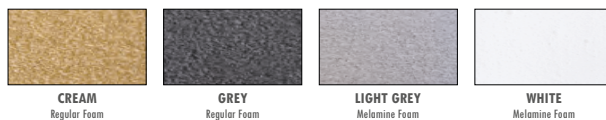

## VELVETY COLOURS

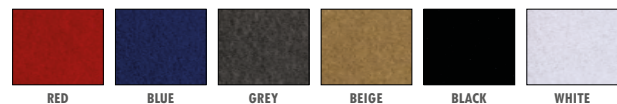

## IMPORTANT NOTICES

- JOCAVI<sup>®</sup> accepts no responsibility for any printing errors. Specifications can be modified without prior notice, if technical or commercial reasons so require.
- The colours shown on this catalogue are only a reference and an illustration of the products finishing. The colours shown are not binding because brightness, contrast and colour balance may vary due to the printing process.
- Colours may vary due to raw-material suppliers' changes and some differences may occur in tonal range.
- Typical Indoor Comfort Standards state a temperature range of 20°C - 27°C (68°F - 81°F), and a relative humidity of less than 60%. These would be considered as normal operational levels of JOCAVI<sup>®</sup> products' range.
- Despite all the standard sizes of all products, this model can be customised upon previous consultation. Sizes may vary slightly due to their production method and some inherent raw-materials characteristics.





# SNOWSORB®

ABSORBENT PANEL

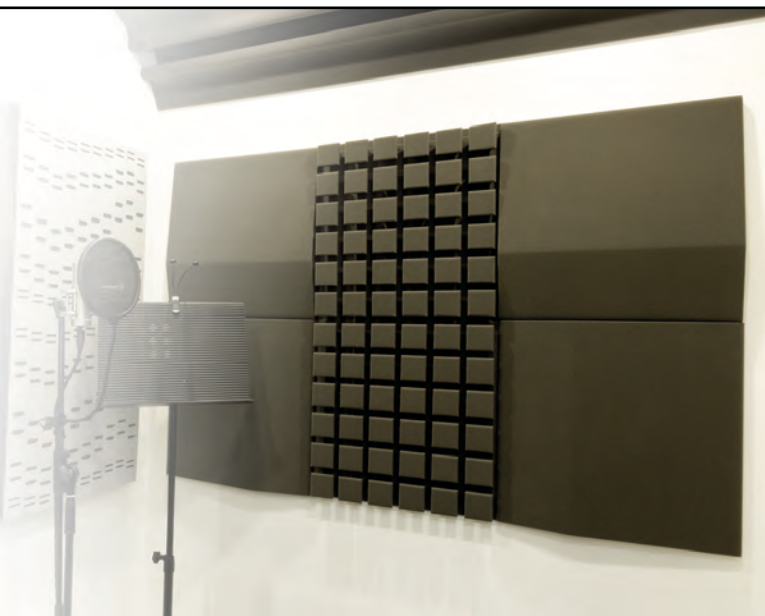

Image of 60x60cm model Ref.:SNW060 (on the left) and Ref.:SNW060 applied (ambient image).

## DESCRIPTION

In order to expand the range of options available on absorption panels, ATP® created the SNOWSORB® with an attractive shape. This model can also be used as a soundproofing reinforcement material.

This panel has a simple aesthetic format that allows various different combinations. It is ideal to be mounted on walls and ceilings, on continuous surfaces or selected spots by combining it with other models.

It is made of regular acoustic foam or of melamine foam as an option.

Commercial areas, Television studios, Pavilions, auditoriums, meeting rooms, public spaces, etc., need specific care regarding airborne noise control. The creation of surfaces that are efficient at absorbing sound waves becomes imperative, and that is the main feature that makes this product so relevant.

Due to its high absorption coefficient and low cost, the SNOWSORB® is specifically recommended product for the acoustic treatment of large areas. It can be easily cut with a sharp utility knife to be adjusted to the dimensions of walls and ceilings.

## TECHNICAL DRAWINGS

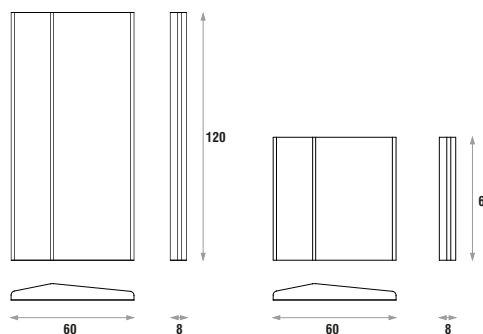

## FEATURES

- Raw material: Melamine Foam or Regular Acoustic Foam.
- NRC: **0.90/m<sup>2</sup>** (>250Hz; <10KHz).
- **MELAMINE FOAM** - Flame resistance: Euroclass B-s1,d0 (similar to old M1 France, Germany B1,GB class1, USA V0/HF1).
- **ACOUSTIC FOAM** - Flame resistance: Euroclass B-s3,d1 (similar to old M1).
- Velvety Finishing available.
- Very easy to install.
- 100% recyclable.

## MODELS AND SIZES

MODELS	HEIGHT	WIDTH	DEPTH	WEIGHT
SNW120	120 cm	60 cm	8 cm	1.2 Kg
SNW060	60 cm	60 cm	8 cm	0.6 Kg

## ABSORPTION COEFFICIENT

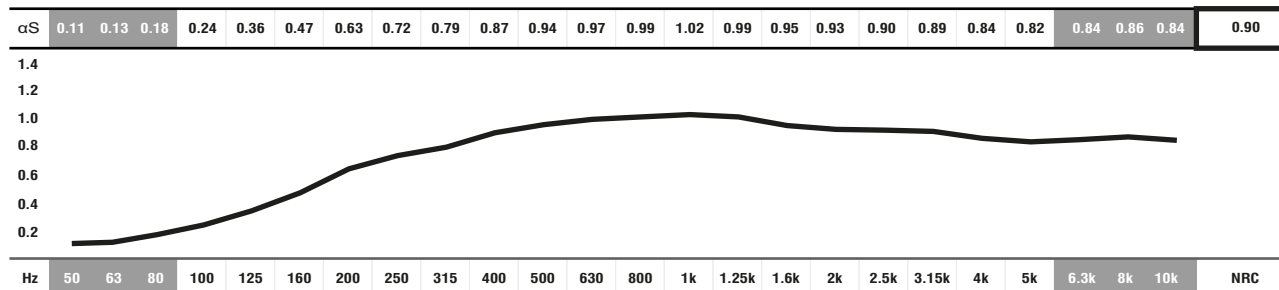

■ ABSORPTION COEFFICIENT: Values in accordance with the standards: EN 20654, ASTM C423 and EN 11654.

■ Values [<100Hz and > 5K] are Non Standard Values.

## REGULAR AND MELAMINE FOAM COLOURS

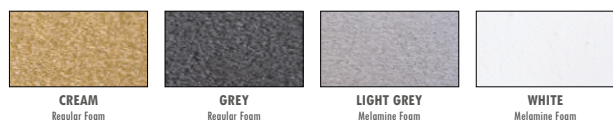

## VELVETY COLOURS

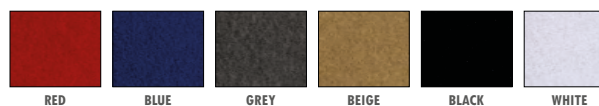

## IMPORTANT NOTICES

- JOCAVI® accepts no responsibility for any printing errors. Specifications can be modified without prior notice, if technical or commercial reasons so require.
- The colours shown on this catalogue are only a reference and an illustration of the products finishing. The colours shown are not binding because brightness, contrast and colour balance may vary due to the printing process.
- Colours may vary due to raw-material suppliers' changes and some differences may occur in tonal range.
- Typical Indoor Comfort Standards state a temperature range of 20°C - 27°C (68°F - 81°F), and a relative humidity of less than 60%. These would be considered as normal operational levels of JOCAVI® products' range.
- Despite all the standard sizes of all products, this model can be customised upon previous consultation. Sizes may vary slightly due to their production method and some inherent raw-materials characteristics.



# SWELL® ABSORBENT PANEL

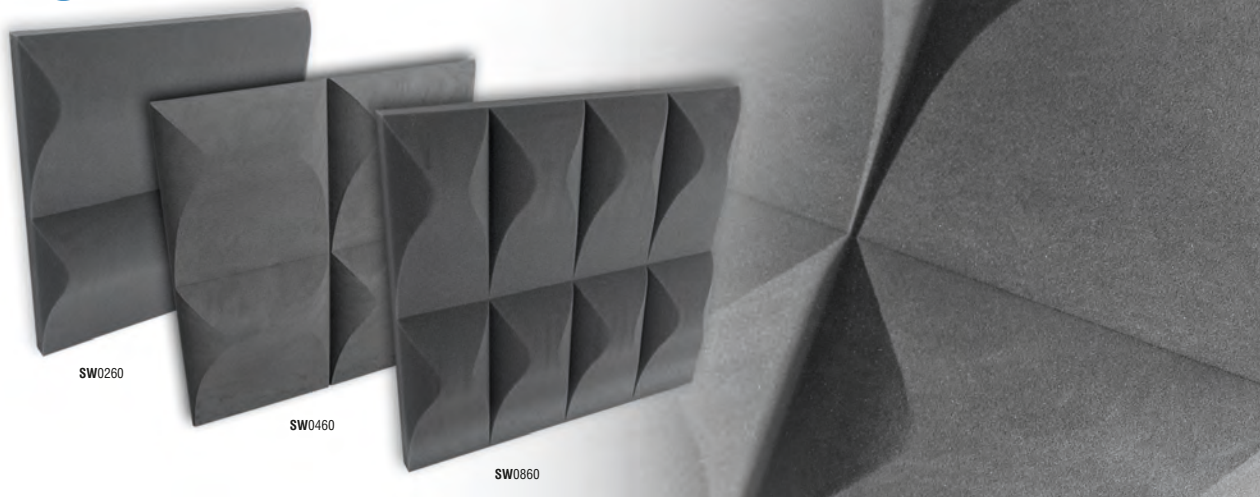

Image of 60x60cm models Ref.:SW0260, Ref.:SW0460 and Ref.:SW0860 (on the left) and Ref.:SW0460 applied (ambient image).

## DESCRIPTION

The SWELL® model is an absorbent panel made of self-extinguishing acoustic foam or melamine foam as an option, thus meeting the highest fire protection requirements. We recommend this model for lining the continuous surfaces of walls and ceilings, which enables a high absorption coefficient and an important sound insulation as well.

The SWELL® can be used as a sound barrier and airborne noise reduction for various types of rooms: commercial areas, television studios, pavilions, auditoriums, meeting rooms, public spaces, etc..

It is a very functional and decorative finishing that meets the performance and aesthetic attributes. Several aesthetic combinations are possible by turning the panel by 90 degrees. It can be easily cut with a knife to be adjusted to the dimensions of walls and ceilings.

## TECHNICAL DRAWINGS

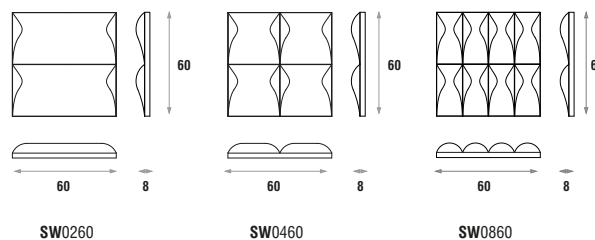

## FEATURES

- Raw material: Melamine Foam or Regular Acoustic Foam.
- NRC: **0.90/m²** [ $>250\text{Hz}; <10\text{KHz}$ ].
- **MELAMINE FOAM** - Flame resistance: Euroclass B-s1,d0 (similar to old M1 France, Germany B1,GB class1, USA V0/HF1).
- **ACOUSTIC FOAM** - Flame resistance: Euroclass B-s3,d1 (similar to old M1).
- Velvety Finishing available.
- Very easy to install.
- 100% recyclable.

## MODELS AND SIZES

MODELS	HEIGHT	WIDTH	DEPTH	WEIGHT
SW0260	60 cm	60 cm	8 cm	0.60 Kg
SW0460	60 cm	60 cm	8 cm	0.60 Kg
SW0860	60 cm	60 cm	8 cm	0.60 Kg

## ABSORPTION COEFFICIENT\*

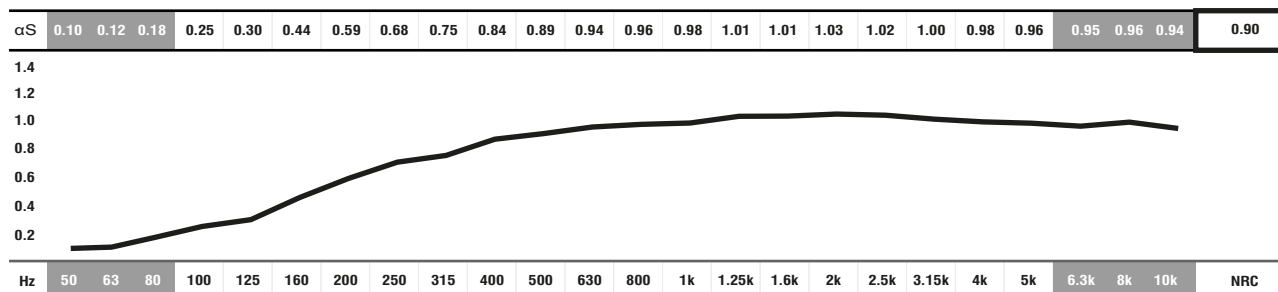

■ ABSORPTION COEFFICIENT: Values in accordance with the standards: EN 20654, ASTM C423 and EN 11654.

■ Values [ $<100\text{Hz}$  and  $>5\text{K}$ ] are Non Standard Values.

\*PANEL DATA ONLY OF REF.: SW0460 REGULAR FOAM.

## REGULAR AND MELAMINE FOAM COLOURS

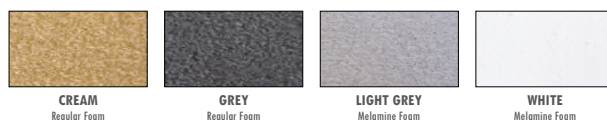

## VELVETY COLOURS

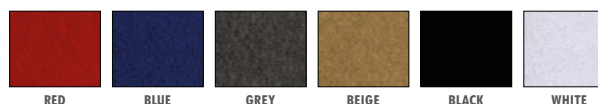

## IMPORTANT NOTICES

- JOCAVI® accepts no responsibility for any printing errors. Specifications can be modified without prior notice, if technical or commercial reasons so require.
- The colours shown on this catalogue are only a reference and an illustration of the products finishing. The colours shown are not binding because brightness, contrast and colour balance may vary due to the printing process.
- Colours may vary due to raw-material suppliers' changes and some differences may occur in tonal range.
- Typical Indoor Comfort Standards state a temperature range of 20°C - 27°C (68°F - 81°F), and a relative humidity of less than 60%. These would be considered as normal operational levels of JOCAVI® products' range.
- Despite all the standard sizes of all products, this model can be customised upon previous consultation. Sizes may vary slightly due to their production method and some inherent raw-materials characteristics.





# DECOART®

ABSORBENT PANEL



Image of a pair of the 96x30cm model Ref.:DAT096 (on the left) and Ref.:DAT096 applied (ambient image).

## DESCRIPTION

The DECOART® is an acoustic treatment absorber made of self-extinguishing acoustic foam. It has an angular arc-shaped geometry describing two elevations "up and down" that make it very attractive when combined with numerous modules.

When observed from a perpendicular perspective, it has a beautiful and harmonised appearance, which is particularly attractive for common areas in public spaces.

The creation of surfaces that are efficient at absorbing sound waves becomes imperative, and that is the main feature that makes this product so relevant.

The DECOART® is perfect to cover continuous areas of walls or ceilings as a coating material and can be used as a soundproofing reinforcement as well.

It is ideal for commercial areas, television studios, pavilions, auditoriums, meeting rooms, public spaces, etc., that need specific care regarding airborne noise control. It can be easily cut with a knife to be adjusted to the dimensions of walls and ceilings.

## TECHNICAL DRAWINGS

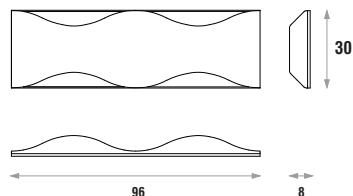

## FEATURES

- Raw material: Melamine Foam or Regular Acoustic Foam.
- NRC: 0.84/m<sup>2</sup> (>250Hz; <10KHz).
- **MELAMINE FOAM** - Flame resistance: Euroclass B-s1,d0 (similar to old M1 France, Germany B1,GB class1, USA V0/HF1).
- **ACOUSTIC FOAM** - Flame resistance: Euroclass B-s3,d1 (similar to old M1).
- Velvety Finishing available.
- Shape and design recommended for continuous surface treatment.
- 100% recyclable.
- Sold in pairs

## MODELS AND SIZES

MODELS	HEIGHT	WIDTH	DEPTH	WEIGHT
DAT096 (pair)	96cm	30 cm	8 cm	0.9 Kg (pair)

SOLD IN PAIRS

## ABSORPTION COEFFICIENT

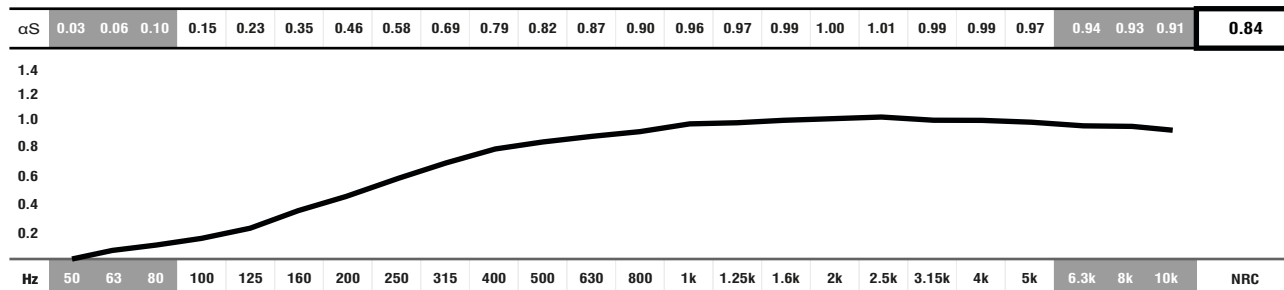

■ ABSORPTION COEFFICIENT: Values in accordance with the standards: EN 20654, ASTM C423 and EN 11654.

■ Values [ $<100\text{Hz}$  and  $>5\text{K}$ ] are Non Standard Values.  
\*PANEL DATA ONLY OF REF.: DAT096 REGULAR FOAM.

## REGULAR AND MELAMINE FOAM COLOURS

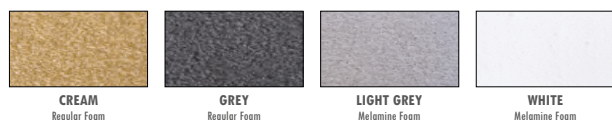

## VELVETY COLOURS

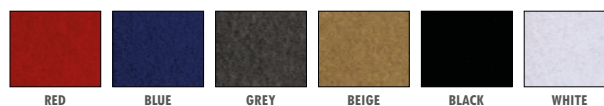

## IMPORTANT NOTICES

- JOCAVI® accepts no responsibility for any printing errors. Specifications can be modified without prior notice, if technical or commercial reasons so require.
- The colours shown on this catalogue are only a reference and an illustration of the products finishing. The colours shown are not binding because brightness, contrast and colour balance may vary due to the printing process.
- Colours may vary due to raw-material suppliers' changes and some differences may occur in tonal range.
- Typical Indoor Comfort Standards state a temperature range of 20°C - 27°C (68°F - 81°F), and a relative humidity of less than 60%. These would be considered as normal operational levels of JOCAVI® products' range.
- Despite all the standard sizes of all products, this model can be customised upon previous consultation. Sizes may vary slightly due to their production method and some inherent raw-materials characteristics.



# BASMEL® ABSORBENT PANEL

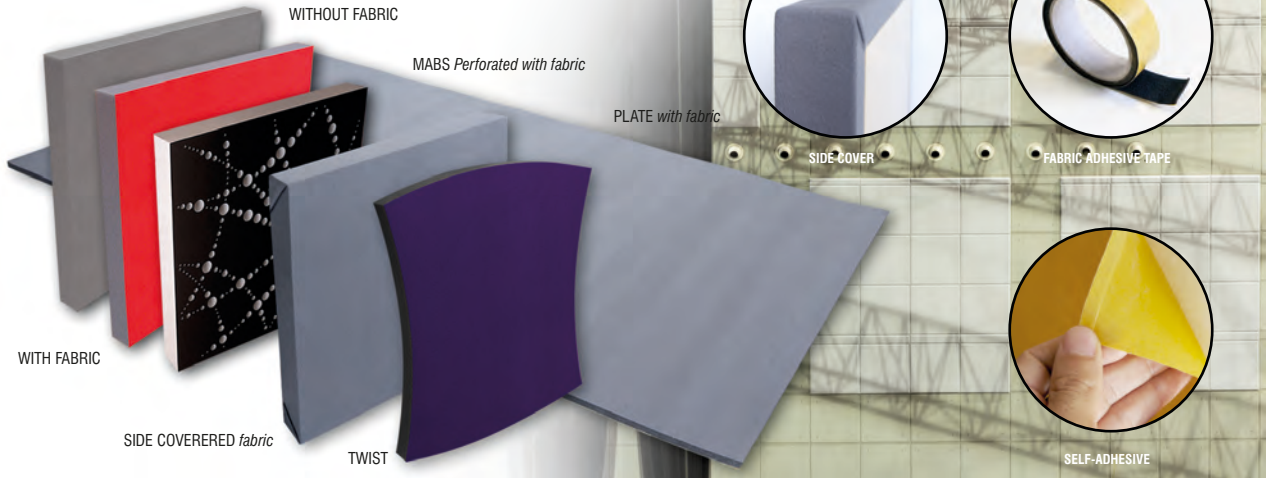

Image of 60x60cm models Ref.:BAL060 fabric (Red),Ref.:BAL060 and Ref.:BAM060 (perforated with black fabric), the new BAL060sc, the BAL200.4 (plate with fabric) and Ref.:BAL200.4 custom made applied (ambient image).

## DESCRIPTION

BASMEL® is a low-cost acoustic panel set to be applied in large quantities on ceilings and walls. It's made of flexible open-cell melamine resin foam or of regular acoustic foam, a thermoset polymer and a fire-resistant fabric-finishing surface. The sound waves penetrate the open-cell structure, thus reducing the reflected energy and giving this product an excellent sound absorption capacity and simultaneously improving soundproofing, thereby providing safety in accordance with environmental standards.

There are several available options; one flat (BAL060/120), other one perforated MABS060 (with the same pattern of the COSMOS® model), BASMEL® SC (with more thickness and side covered with fabric - thus reducing the reflected energy and giving this product an excellent sound absorption capacity), BASMEL® Plates (with more coverage area) and the most recent, the BASMEL® Twist®. All these models have different possibilities (different foams, fabric colours, shapes, etc).

The BASMEL®'s acoustic and safety characteristics make this product ideal for use as a noise control and sound insulation device in buildings that have demanding requirements against fire. It improves acoustics and soundproofing, thereby providing safety in accordance with environmental standards.

Homes, meeting rooms, offices and hotel foyers can be acoustically upgraded just as effective and attractive by using this product. The installation method is very simple by using mounting glue or can be provided with self-adhesive on the back. To conceal the union between the panels, we also have, as an option, a roll of fabric adhesive tape (with 500x3cm) that can be applied.

## FEATURES

- Raw material: Melamine Foam or Regular Acoustic Foam.
- NRC: **0.80/m²** (40mm), **0.54/m²** (20mm) and **0.90/m²** (80mm - SIDE COVER Panels).
- **MELAMINE FOAM** - Flame resistance: Euroclass B-s1,d0 (similar to old M1 France, Germany B1,GB class1, USA V0/HF1).
- **ACOUSTIC FOAM** - Flame resistance: Euroclass B-s3,d1 (similar to old M1).
- Minimum 4 units (SIDE COVER panels) and 8 units.
- Mounting glue and **FABRIC ADHESIVE FINISHING TAPE** sold separately.
- **SELF-ADHESIVE** option available on request.

## TECHNICAL DRAWINGS

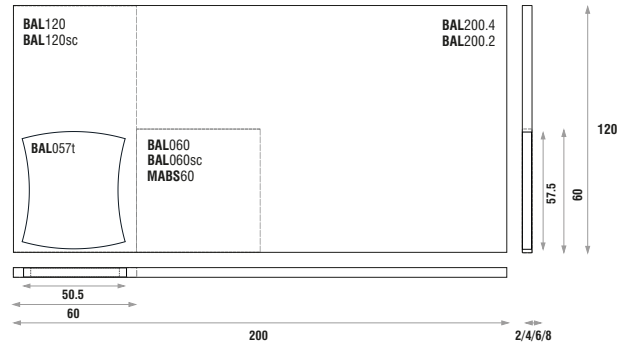

## MODELS AND SIZES

MODELS	RF Regular Foam	MF Melamine Foam	FRF Fabric RF	FMF Fabric MF	SA Self-Adhesive	SIZES (cm)	WEIGHT (Kg)
■ TWT057	X	X	X	X	X	57,5x50,5x4	0.30/0.22
■ BAL120	X	X	X	X	X	120x60x4	0.60/0.44
■ BAL060	X	X	X	X	X	60x60x4	0.30/0.22
■ BAL200.4	X	X	X	X	X	200x120x4	2.24/1.52
■ BAL200.2	X	X	X	X	X	200x120x2	1.48/0.76
■ BAL120sc				X	X	120x60x8	0.62/0.46
■ BAL060sc				X	X	60x60x8	0.31/0.23
■ MABS060	X	X	X	X	X	60x60x4cm	0.21

## ABSORPTION COEFFICIENT

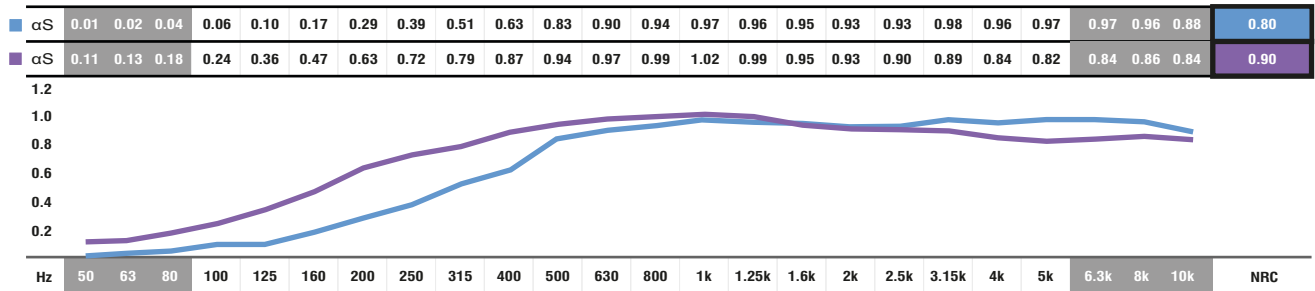

■ ABSORPTION COEFFICIENT: Values in accordance with the standards: EN 20654, ASTM C423 and EN 11654.

■ Values (<100Hz and > 5K) are Non Standard Values.

## STANDARD FABRIC COLOURS

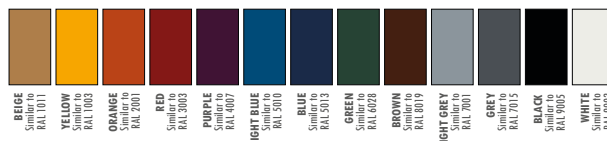

## REGULAR AND MELAMINE FOAM COLOURS

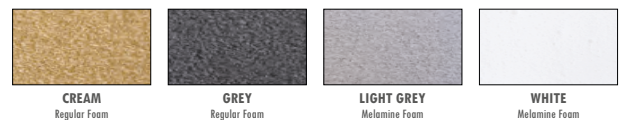

## IMPORTANT NOTICES

- JOCAVI® accepts no responsibility for any printing errors. Specifications can be modified without prior notice, if technical or commercial reasons so require.
- RAL® is an international independent colour standard system partner for industry, trade, architecture and design. Should be consulted before placing any order.
- The colours shown on this catalogue are only a reference and an illustration of the products finishing. The colours shown are not binding because brightness, contrast and colour balance may vary due to the printing process.
- Colours may vary due to raw-material suppliers' changes and some differences may occur in tonal range.
- Typical Indoor Comfort Standards state a temperature range of 20°C - 27°C (68°F - 81°F), and a relative humidity of less than 60%. These would be considered as normal operational levels of JOCAVI® products' range.
- Despite all the standard sizes of all products, this model can be customised upon previous consultation. Sizes may vary slightly due to their production method and some inherent raw-materials characteristics.



# WATERCOT®

ABSORBENT PANEL - SUSPENDED AND WALL PANELS



WATERCOT® WAL  
REF: WAW120

WATERCOT® BAF  
REF: WAB120



WAB120



WAW120

Image of Watercot® models Ref.:WAW120 (on the left) and Ref.:WAB120 models. Watercot® WAL model (ambient image).

## DESCRIPTION

This model comes in two versions: the WATERCOT®BAF, which is a suspension baffle for ceilings, and the WATERCOT®WAL, which is a covering material for walls and ceilings. The latter is provided with its own glue, a self-adhesive film, and it is very easily applied.

The WATERCOT® is manufactured with one component only, i.e., closed-cell polyethylene foam, whose cells are open by perforation at a later process during manufacture. The result is a very efficient material for acoustic treatment.

The several advantages of this product are its weight, price, durability and moisture resistance. When compared to other similar materials, i.e., polyester-foam and melamine-foam, this material has distinct advantages which allow its use in rather wet environments and outdoors, given its resistance to moisture and water.

One of the key features of this foam is actually its capacity to remain physically and acoustically unchanged when exposed to water and moisture.

These two products, the WATERCOT®WAL and the WATERCOT®BAF, are yet another option of acoustic treatment provided by JOCAVI®, mainly when both moisture and fire resistance requirements are essential criteria. It is a mandatory tool for airborne noise control problems and a very low-cost solution.

## FEATURES

- Raw material: PE Foam.
- Excellent acoustic properties NRC: (**Watercot® WAL - 0.82/m²**) and (**Watercot® BAF - 0.86/m²**).
- Flame resistance: Euroclass B (similar to old M1 France, B1 Class (DIN 4102), GB class1, V0/HF1(UL94). Meets all fire policies required for the Building & Construction. No volatile mineral fibres.
- It withstands the direct contact with water and may be washed by water pressure.
- Water absorption: %Vol. (28d-95%HR) < 4 %vol. Density: 30kg/m³
- Low average weight that allows light fastening structures.
- Easy installation: **Self-adhesive Watercot® WAL and Watercot® BAF suspension panel.**

## ABSORPTION COEFFICIENT

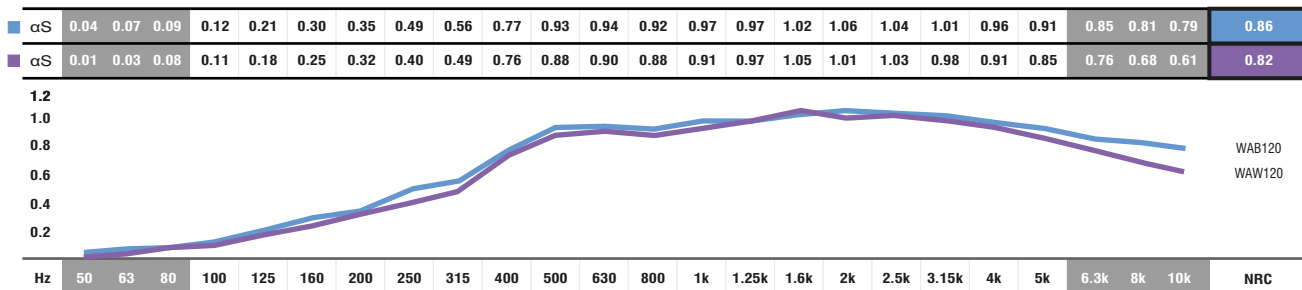

ABSORPTION COEFFICIENT: Values in accordance with the standards: EN 20654, ASTM C423 and EN 11654.

■ Values [ $< 100\text{Hz}$  and  $> 5\text{K}$ ] are Non Standard Values.

■ Watercot® BAF model: values obtained with one panel per m², suspended from the ceiling.

■ Watercot® WAL model: values obtained with one panel per m², with the product glued to a concrete wall.

## STANDARD COLOURS

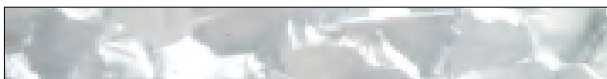

WHITE



BLACK

## IMPORTANT NOTICES

- JOCAVI® accepts no responsibility for any printing errors. Specifications can be modified without prior notice, if technical or commercial reasons so require.
- The colours shown on this catalogue are only a reference and an illustration of the products finishing. The colours shown are not binding because brightness, contrast and colour balance may vary due to the printing process.
- Colours may vary due to raw-material suppliers' changes and some differences may occur in tonal range.
- Typical Indoor Comfort Standards state a temperature range of 20°C - 27°C (68°F - 81°F), and a relative humidity of less than 60%. These would be considered as normal operational levels of JOCAVI® products' range.
- Despite all the standard sizes of all products, this model can be customised upon previous consultation. Sizes may slightly vary due to their production method and some inherent raw-materials characteristics.

## TECHNICAL DRAWINGS

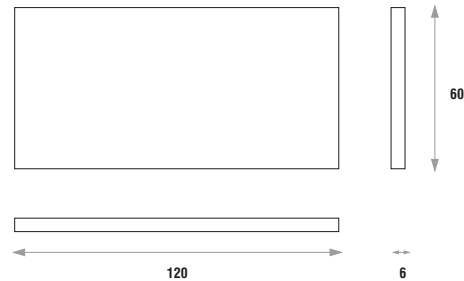

## MODELS AND SIZES

MODELS	HEIGHT	WIDTH	DEPTH	WEIGHT
■ WAW120	120 cm	60 cm	6 cm	0.46 Kg
■ WAB120	120 cm	60 cm	6 cm	0.44 Kg





# WIDEBAFFLE®

ABSORBENT PANEL



WBF120

WLS120

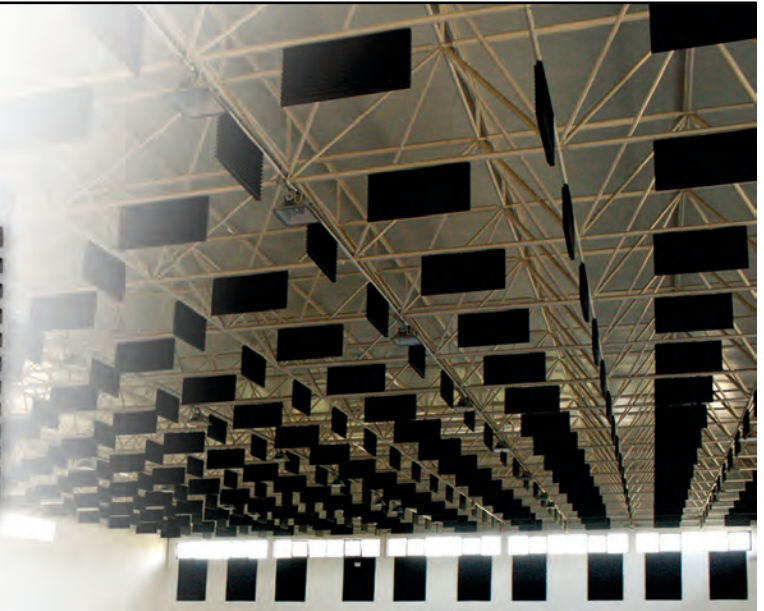

Image of 120x60cm models Ref.:WBF120 and Ref.:WLS120 (on the left) and Ref.:WBF120 applied (ambient image).

## DESCRIPTION

WIDEBAFFLE® is our acoustic baffle to be applied in large rooms. This baffle is ideal to reduce reverberation time and airborne noise in gyms, pools, cafeterias, churches, schools, nightclubs, metal buildings and multipurpose rooms. It is a mandatory tool for airborne noise control problems and a very low cost solution.

The WIDEBAFFLE® is easy to install and can be assembled in very different aesthetic combinations. These sound baffles are typically suspended from the ceiling, and may also be used as acoustic wall panels, helping decrease the reflected sound energy.

And now we have another model with the same efficiency but with a different design, the WIDEBAFFLELS® (WLS120).

## TECHNICAL DRAWINGS

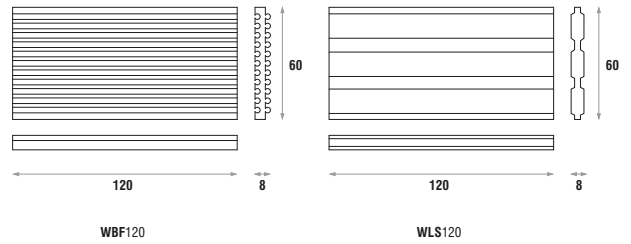

## FEATURES

- Raw material: Melamine Foam or Regular Acoustic Foam.
- NRC: **0.87/m²** [ $>250\text{Hz}; <10\text{KHz}$ ].
- **MELAMINE FOAM** - Flame resistance: Euroclass B-s1,d0 (similar to old M1 France, Germany B1,GB class1, USA V0/HF1).
- **ACOUSTIC FOAM** - Flame resistance: Euroclass B-s3,d1 (similar to old M1).
- Very easy to install.
- 100% recyclable.

## MODELS AND SIZES

MODELS	HEIGHT	WIDTH	DEPTH	WEIGHT
WBF120	120 cm	60 cm	8 cm	1 Kg
WLS120	120 cm	60 cm	8 cm	1 Kg

## ABSORPTION COEFFICIENT

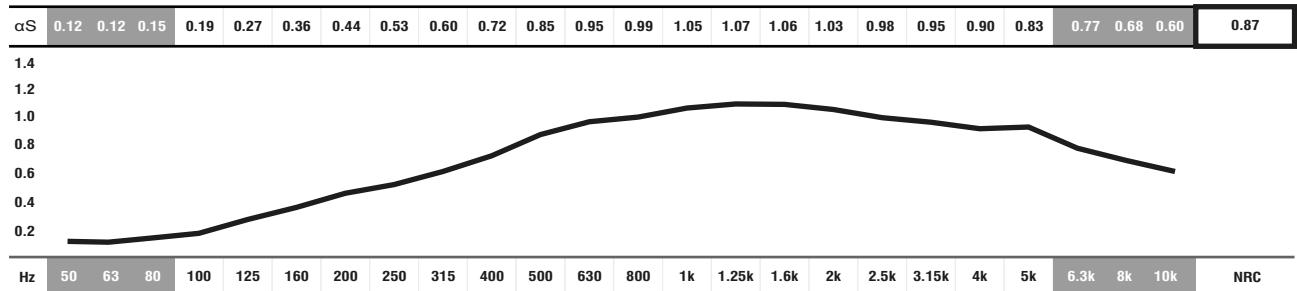

■ ABSORPTION COEFFICIENT: Values in accordance with the standards: EN 20654, ASTM C423 and EN 11654.

■ Values [ $<100\text{Hz}$  and  $>5\text{K}$ ] are Non Standard Values.

\*PANEL DATA ONLY OF REF.: WBF120 REGULAR FOAM.

## REGULAR AND MELAMINE FOAM COLOURS



CREAM  
Regular Foam



GREY  
Regular Foam



LIGHT GREY  
Melamine Foam



WHITE  
Melamine Foam

## IMPORTANT NOTICES

- JOCAVI® accepts no responsibility for any printing errors. Specifications can be modified without prior notice, if technical or commercial reasons so require.
- The colours shown on this catalogue are only a reference and an illustration of the products finishing. The colours shown are not binding because brightness, contrast and colour balance may vary due to the printing process.
- Colours may vary due to raw-material suppliers' changes and some differences may occur in tonal range. Close attention must be paid to the storage conditions and the acclimatization before, during and after the installation.
- Typical Indoor Comfort Standards state a temperature range of 20°C - 27°C (68°F - 81°F), and a relative humidity of less than 60%. These would be considered as normal operational levels of JOCAVI® products' range.
- Despite all the standard sizes of all products, this model can be customised upon previous consultation. Sizes may vary slightly due to their production method and some inherent raw-materials characteristics.





# TRAP<sup>®</sup> 30R / 30S / 40

ABSORBENT PANEL

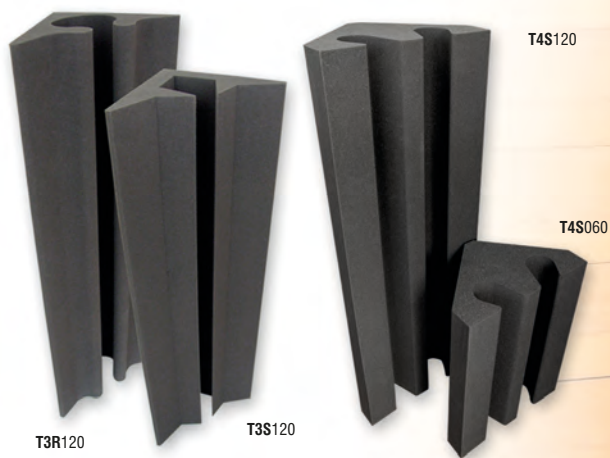

Image of 120x30cm models Ref.:T3R120, Ref.:T3S120 and Ref.:T4S120 and T4S060(on the left) and Ref.:T4S120 applied (ambient image).

## DESCRIPTION

TRAP 30S<sup>®</sup> and TRAP 30R<sup>®</sup> are node reduction tools of low-frequencies. They are made of high-quality controlled-cell, self-extinguishable M1 fire-retardant acoustic foam. Bass corners' absorbers are substantially adequate to control nodes in rooms. This simple and affordable solution provides immediate results for those who do not want time-consuming building solutions. The TRAP 30S<sup>®</sup> and TRAP 30R<sup>®</sup> are effective low-frequency smoothing panels at a price affordable to everybody.

This model proposes two optional shapes: one with straight lines and another one with curved lines.

The TRAP<sup>®</sup> 40S is a low frequencies reduction tool. It is made of high-quality controlled-cell, self-extinguishable M1 fire-retardant acoustic foam.

Bass corners' absorbers are substantially recommended to control Low Frequencies in rooms.

The TRAP<sup>®</sup> 40S is an effective low-frequency absorber panel used for corners, meant to be placed in 90° corners.

This model proposes an attractive shape with curved lines at a very affordable price.

## FEATURES

- **FINISHINGS AVAILABLE:** Regular Foam or the Velvety Finishing.
- NRC: TRAP 30S/R **0.84/m<sup>2</sup>**;  
TRAP 40S **0.86/m<sup>2</sup>** [ $>250\text{Hz}$ ;  $<10\text{KHz}$ ].
- **ACOUSTIC FOAM** - Flame resistance: Euroclass B-s3,d1 (similar to old M1).
- Very easy to install.

## TECHNICAL DRAWINGS

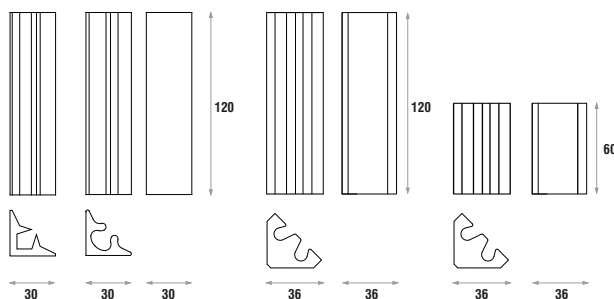

## MODELS AND SIZES

MODELS	HEIGHT	WIDTH	DEPTH	WEIGHT
T3S120	120 cm	30 cm	30 cm	0.9 Kg
T3R120	120 cm	30 cm	30 cm	0.9 Kg
T4S120	120cm	36 cm	36 cm	1.8 Kg
T4S060	60 cm	36 cm	36 cm	0.9 Kg

## ABSORPTION COEFFICIENT

$\alpha_S$	0.04	0.05	0.10	0.24	0.44	0.64	0.75	0.82	0.80	0.73	0.76	0.82	0.88	0.95	0.96	0.95	0.92	0.93	0.94	0.93	0.94	0.95	0.95	0.95	0.86
$\alpha_S$	0.00	0.02	0.06	0.11	0.39	0.58	0.70	0.80	0.77	0.63	0.71	0.80	0.87	0.94	0.95	0.93	0.89	0.97	0.91	0.93	0.94	0.95	0.95	0.97	0.84

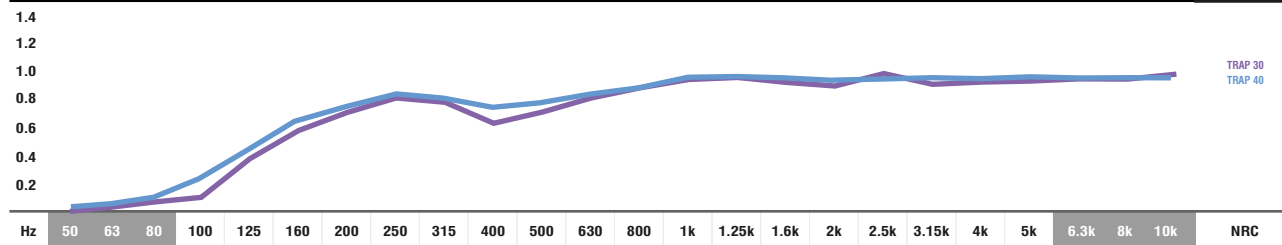

■ ABSORPTION COEFFICIENT: Values in accordance with the standards: EN 20654, ASTM C423 and EN 11654. ■ Values [ $<100\text{Hz}$  and  $>5\text{K}$ ] are Non Standard Values.

## REGULAR FOAM COLOURS

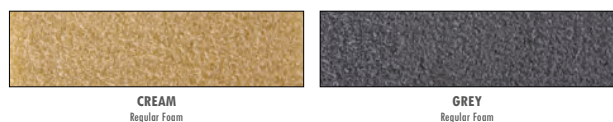

## VELVETY COLOURS

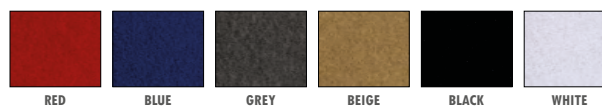

## IMPORTANT NOTICES

- JOCAVI<sup>®</sup> accepts no responsibility for any printing errors. Specifications can be modified without prior notice, if technical or commercial reasons so require.
- The colours shown on this catalogue are only a reference and an illustration of the products finishing. The colours shown are not binding because brightness, contrast and colour balance may vary due to the printing process.
- Colours may vary due to raw-material suppliers' changes and some differences may occur in tonal range.
- Typical Indoor Comfort Standards state a temperature range of 20°C - 27°C (68°F - 81°F), and a relative humidity of less than 60%. These would be considered as normal operational levels of JOCAVI<sup>®</sup> products' range.
- Despite all the standard sizes of all products, this model can be customised upon previous consultation. Sizes may vary slightly due to their production method and some inherent raw-materials characteristics.





# LF CAMOU®

TUNED ABSORPTION PANEL



Image of 60x60cm model Ref.:LFA060 (on the left) and Ref.:LFA120 applied (ambient image).

## DESCRIPTION

The LF CAMOU® is a low-frequency absorption panel suitable for applying in the 90° corners of rooms. The absorption peak of this panel is at 100 Hz. It combines a high-density foam box with JOCAVI®'s fabric finishing. It has exactly the same finishing as the CAMOU® absorbent panel, so we can combine the two models with the same aesthetics. The combined use with CAMOU® will increase the absorption of the nearest harmonic frequencies.

The closed resonance chamber has sufficient mass and density to provide a very concentrated and effective absorption coefficient. This panel will become one of the most efficient and inexpensive offers in the market for low-frequency absorbent materials.

This panel is mounted by pasting it with our recommended adhesive glue.

The LF CAMOU® is designed to fit and match the CAMOU® or any other 80mm thickness models.

In order to boost bass absorption, we recommend that you use a number of panels enough to fill all the edge corners of the room.

## TECHNICAL DRAWINGS

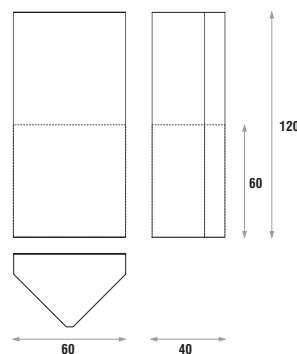

## MODELS AND SIZES

MODELS	HEIGHT	WIDTH	DEPTH	WEIGHT
LFA120	120 cm	40 cm	40 cm	8.8 Kg
LFA060	60 cm	40 cm	40 cm	4.4 Kg

## FEATURES

- Made up of high-density PU foam and Fabric finishing plate.
- Average absorption: **0.77/m<sup>2</sup>** (>63Hz; <500Hz).
- Tuned to 100 Hz.
- Fire-resistance: Fabric - Euroclass B (similar to old M1); HD PU Foam Euroclass B-s3,d1 (similar to old M1).
- Designed to fit and match any 80mm thickness models.
- Very easy to install.

## ABSORPTION COEFFICIENT

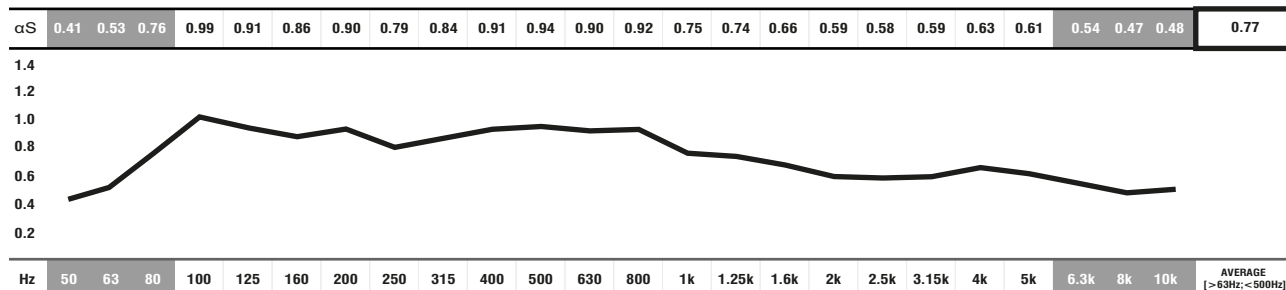

■ ABSORPTION COEFFICIENT: Values in accordance with the standards: EN 20654, ASTM C423 and EN 11654.

■ Values [<100Hz and > 5k] are Non Standard Values.

## STANDARD FABRIC COLOURS

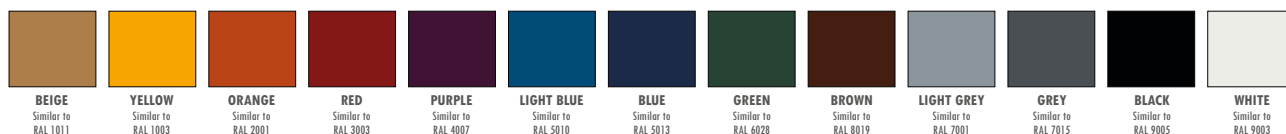

## IMPORTANT NOTICES

- JOCAVI® accepts no responsibility for any printing errors. Specifications can be modified without prior notice, if technical or commercial reasons so require.
- RAL® is an international independent colour standard system partner for industry, trade, architecture and design. Should be consulted before placing any order.
- The colours shown on this catalogue are only a reference and an illustration of the products finishing. The colours shown are not binding because brightness, contrast and colour balance may vary due to the printing process.
- Colours may vary due to raw-material suppliers' changes and some differences may occur in tonal range.
- Typical Indoor Comfort Standards state a temperature range of 20°C - 27°C (68°F - 81°F), and a relative humidity of less than 60%. These would be considered as normal operational levels of JOCAVI® products' range.
- Sizes may vary slightly due to their production method and some inherent raw-materials characteristics.



# LF COSMOS<sup>®</sup>

TUNED ABSORPTION PANEL



Image of 60x60cm model Ref.:LF0060 (on the left) and Ref.:LF0060 applied (ambient image).

## DESCRIPTION

The LF COSMOS<sup>®</sup> is a low-frequency absorbent panel suitable for applying in the 90° corners of rooms. The absorption peak of this panel is at 100 Hz. It combines a high-density foam box with JOCAVI<sup>®</sup>'s melamin faced board finishings. It has exactly the same finishing as the COSMOS<sup>®</sup> absorbent panel, so we can combine the two models with the same aesthetics. The combined use with COSMOS<sup>®</sup> will increase the absorption of the nearest harmonic frequencies.

The closed resonance chamber has sufficient mass and density to provide a very concentrated and effective absorption coefficient. This panel will become one of the most efficient and inexpensive offers in the market for low-frequency absorbent materials.

This panel is mounted by pasting it with our recommended adhesive glue. The LF COSMOS<sup>®</sup> is designed to fit and match the COSMOS<sup>®</sup> or any other 80mm thickness models.

In order to boost bass absorption, we recommend that you use a number of panels enough to fill all the edge corners of the room.

## FEATURES

- Made up of high-density PU foam and Rigid melamine faced board plate.
- Average absorption: **0.75/m<sup>2</sup>** [ $>63\text{Hz}; <500\text{Hz}$ ].
- Tuned to 100 Hz.
- Fire-resistance: Melamine Faced Board - Euroclass B-s2,d0 (similar to old M1); HD PU Foam Euroclass B-s3,d1 (similar to old M1).
- 4 perforations and 6 melamine faced boards finishings.
- Designed to fit and match any 80mm thickness models.
- Very easy to install.

## TECHNICAL DRAWINGS

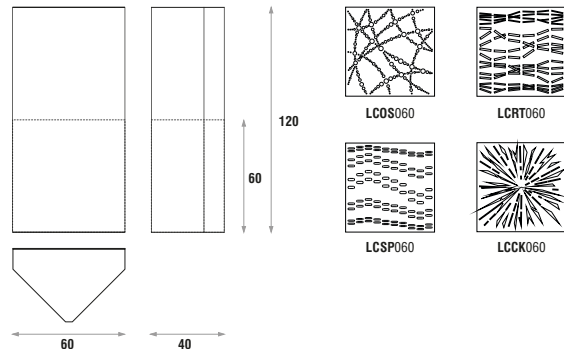

## MODELS AND SIZES

MODELS	HEIGHT	WIDTH	DEPTH	WEIGHT
LF0120	120 cm	40 cm	40 cm	8.8 Kg
LF0060	60 cm	40 cm	40 cm	4.4 Kg

## ABSORPTION COEFFICIENT

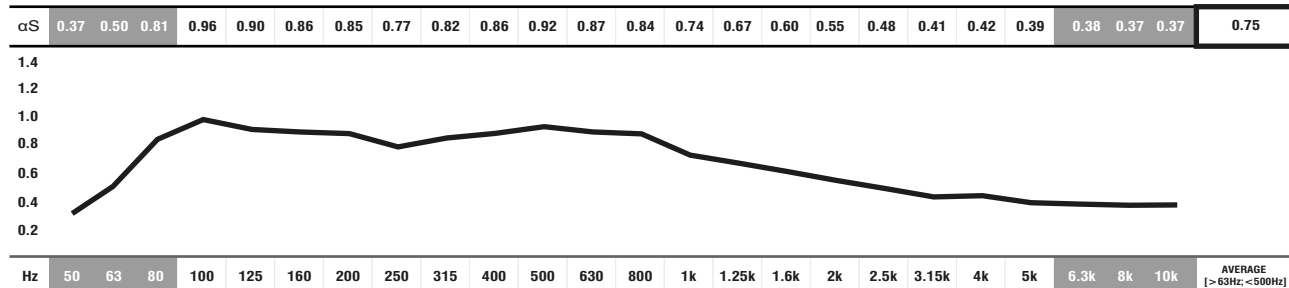

■ ABSORPTION COEFFICIENT: Values in accordance with the standards: EN 20654, ASTM C423 and EN 11654.

■ Values [ $<100\text{Hz}$  and  $> 5\text{K}$ ] are Non Standard Values.

## MELAMINE FACED BOARD FINISHINGS



## IMPORTANT NOTICES

- JOCAVI<sup>®</sup> accepts no responsibility for any printing errors. Specifications can be modified without prior notice, if technical or commercial reasons so require.
- The colours shown on this catalogue are only a reference and an illustration of the products finishing. The colours shown are not binding because brightness, contrast and colour balance may vary due to the printing process.
- Colours may vary due to raw-material suppliers' changes and some differences may occur in tonal range.
- Due to its natural origin, wood-based products will always present natural imperfections inherent to the organic nature. And for similar reasons, they will also present traces of old-age in the course of time.
- Wood and Fabric products are highly susceptible to change its appearance with humidity and temperature. Close attention must be paid to the storage conditions and the acclimatization before, during and after the installation.
- Typical Indoor Comfort Standards state a temperature range of 20°C - 27°C (68°F - 81°F), and a relative humidity of less than 60%. These would be considered as normal operational levels of JOCAVI<sup>®</sup> products' range.
- Despite all the standard sizes of all products, this model can be customised upon previous consultation. Sizes may vary slightly due to their production method and some inherent raw-materials characteristics.





# BASSKEEPER WALL®

TUNED ABSORPTION PANEL

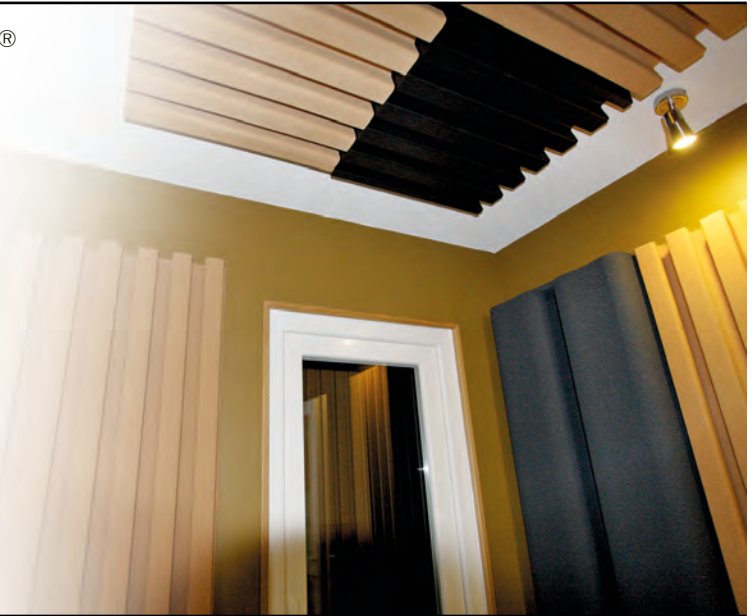

Image of 120x60cm model Ref.:BKW120 (on the left) and Ref.:BKW120 applied (ambient image).

## DESCRIPTION

The BASSKEEPER WALL® is the ATP® solution for the absorption of low frequencies and it is meant to be mounted on walls and ceilings.

When combined with the BASSKEEPER ANGLE®, it provides the best ATP® choice among the low-frequency products.

This bass trap is an open resonance box model, tuned to 160 Hz, like the BASSKEEPER ANGLE®, and you can match them. These two products together provide a true linear tool and a first-class approach to tame low frequencies and take perfect control of the basses.

In most situations, these two models combined solve most problems caused by the excess of low frequencies in the room.

Several colours are at your disposal.

## TECHNICAL DRAWINGS

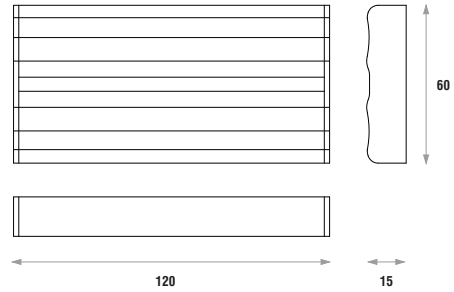

## FEATURES

- Raw material: HD EPS with Coloured Projectable Cellulose Finishing.
- Average absorption: **0.66/m²** [ $>100\text{Hz}; <250\text{Hz}$ ].
- Fire-resistance: Projectable Cellulose - Euroclass A2-s1,d0 (similar to old M0); EPS - Euroclass B-s3,d1 (similar to old M1).
- Very easy to install.
- Other colours available upon consultation.

## MODELS AND SIZES

MODELS	HEIGHT	WIDTH	DEPTH	WEIGHT
BKW120	120 cm	60 cm	15 cm	3.1 Kg

## ABSORPTION COEFFICIENT

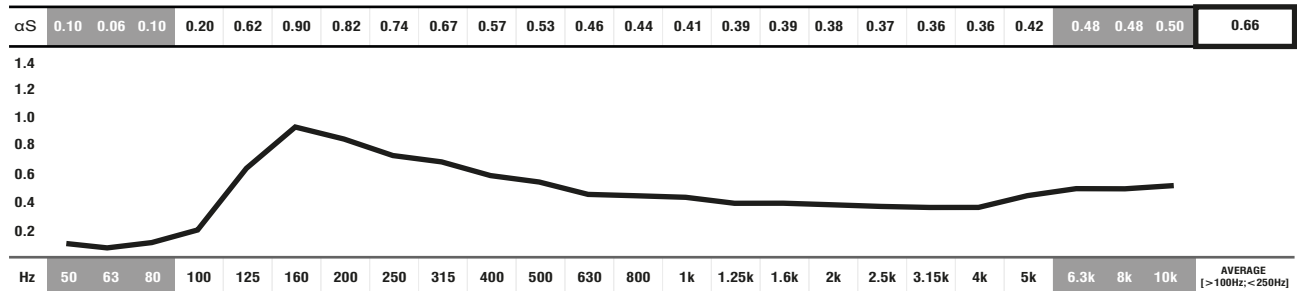

■ ABSORPTION COEFFICIENT: Values in accordance with the standards: EN 20654, ASTM C423 and EN 11654.

■ Values [ $<100\text{Hz}$  and  $> 5\text{K}$ ] are Non Standard Values.

## STANDARD PROJECTABLE CELLULOSE FINISHING COLOURS



## IMPORTANT NOTICES

- JOCAVI® accepts no responsibility for any printing errors. Specifications can be modified without prior notice, if technical or commercial reasons so require.
- RAL® is an international independent colour standard system partner for industry, trade, architecture and design. Should be consulted before placing any order.
- The colours shown on this catalogue are only a reference and an illustration of the products finishing. The colours shown are not binding because brightness, contrast and colour balance may vary due to the printing process.
- Colours may vary due to raw-material suppliers' changes and some differences may occur in tonal range.
- Typical Indoor Comfort Standards state a temperature range of 20°C - 27°C (68°F - 81°F), and a relative humidity of less than 60%. These would be considered as normal operational levels of JOCAVI® products' range.
- Sizes may vary slightly due to their production method and some inherent raw-materials characteristics.



# BASSKEEPER ANGLE®

TUNED ABSORPTION PANEL



Image of 120x40cm model Ref.:BKA120 (on the left) and Ref.:BKA120 applied (ambient image).

## DESCRIPTION

The BASSKEEPER ANGLE® is the best proposal from the ATP® low-frequency absorption panels. It produces an overpowering effect in the corners of the room where the basses build-up is most often present. The BASSKEEPER ANGLE® is an open resonance box model, tuned to 160 Hz, thus being very effective.

The BASSKEEPER ANGLE® and the BASSKEEPER WALL® have the same shape and are bass traps. The BASSKEEPER ANGLE® is applied in corners while the BASSKEEPER WALL® is applied on walls. It is a first-rate approach to tame low-frequency anomalies in your room.

In most cases, the combination of these two models solves all problems caused by the accumulation of low frequencies in the room, by allowing you to create your own design while providing acoustic control of low frequencies.

## TECHNICAL DRAWINGS

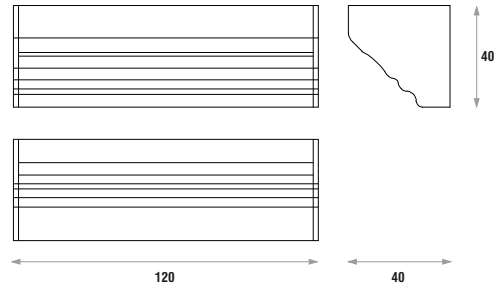

## FEATURES

- Raw material: HD EPS with Coloured Projectable Cellulose Finishing.
- Average absorption: **0.78/m²** [ $>100\text{Hz}; <250\text{Hz}$ ].
- Fire-resistance: Projectable Cellulose - Euroclass A2-s1,d0 (similar to old M0); EPS - Euroclass B-s3,d1 (similar to old M1).
- Very easy to install.
- Other colours available upon consultation.

## MODELS AND SIZES

MODELS	HEIGHT	WIDTH	DEPTH	WEIGHT
BKA120	120 cm	40 cm	40 cm	3.6 Kg

## ABSORPTION COEFFICIENT

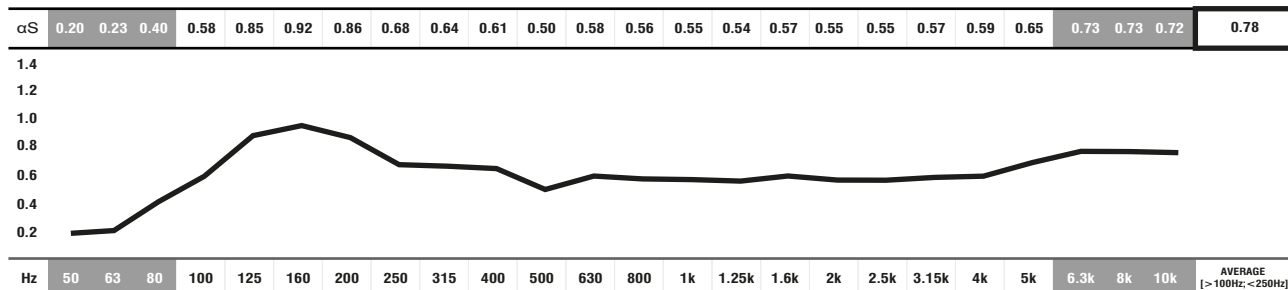

■ ABSORPTION COEFFICIENT: Values in accordance with the standards: EN 20654, ASTM C423 and EN 11654.

■ Values [ $<100\text{Hz}$  and  $> 5\text{K}$ ] are Non Standard Values.

## STANDARD PROJECTABLE CELLULOSE FINISHING COLOURS

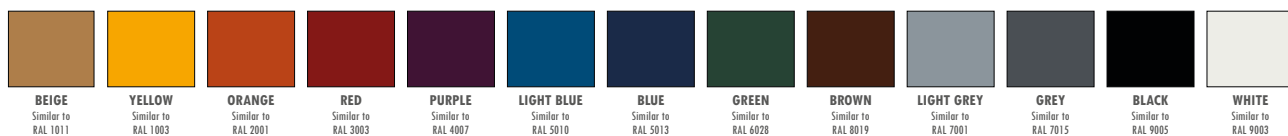

## IMPORTANT NOTICES

- JOCAVI® accepts no responsibility for any printing errors. Specifications can be modified without prior notice, if technical or commercial reasons so require.
- RAL® is an international independent colour standard system partner for industry, trade, architecture and design. Should be consulted before placing any order.
- The colours shown on this catalogue are only a reference and an illustration of the products finishing. The colours shown are not binding because brightness, contrast and colour balance may vary due to the printing process.
- Colours may vary due to raw-material suppliers' changes and some differences may occur in tonal range.
- Typical Indoor Comfort Standards state a temperature range of 20°C - 27°C (68°F - 81°F), and a relative humidity of less than 60%. These would be considered as normal operational levels of JOCAVI® products' range.
- Sizes may vary slightly due to their production method and some inherent raw-materials characteristics.



# SLIMBASS ANGLE®

TUNED ABSORPTION PANEL

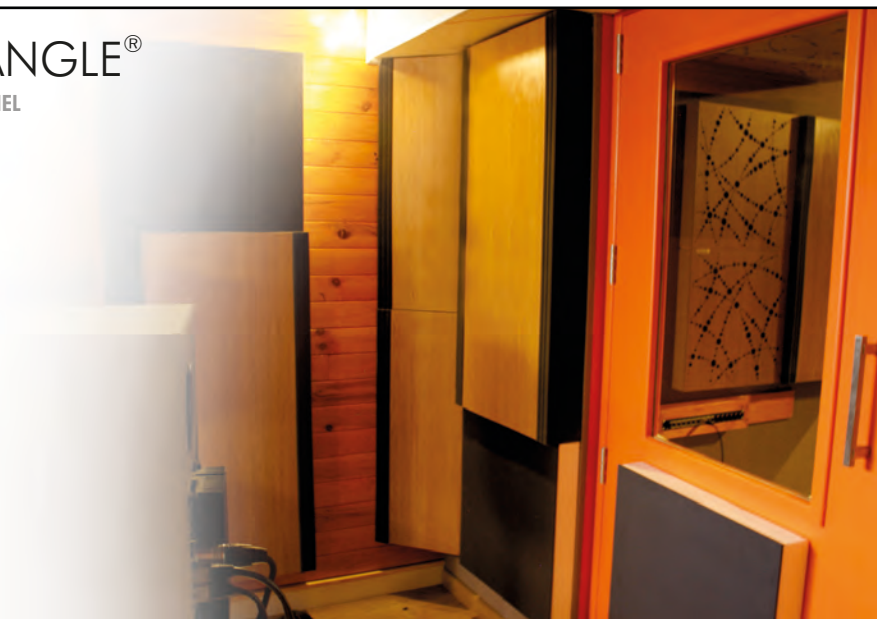

Image of 120x30cm model Ref.:SLB120 (on the left) and Ref.:SLB120 applied (ambient image).

## DESCRIPTION

Music rooms, studios, rehearsal rooms, etc., requires surfaces that are efficient at absorbing low-frequencies.

ATP® proposes the SLIMBASS ANGLE® absorbent panel for the absorption of low-frequencies.

It is made of high-quality controlled-cell regular acoustic foam with a wooden-like melamine faced board finish plate. It forms inside it a 160 Hz closed resonance box.

The SLIMBASS ANGLE® panel has a thin and elegant design, which is appropriate for the 90° corners of the room's walls or ceilings.

## TECHNICAL DRAWINGS

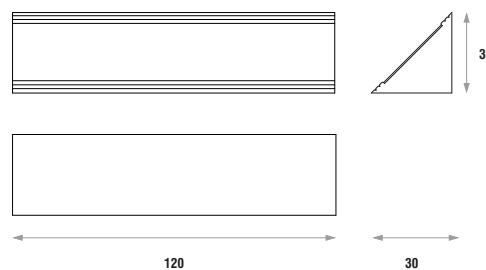

## FEATURES

- Raw material: Refular Foam and rigid Melamine Faced Board plate.
- Average absorption: **0.55/m<sup>2</sup>** [ $> 100\text{Hz}; < 250\text{Hz}$ ].
- Fire-resistance: Melamine Faced Board - Euroclass B-s2,d0 (similar to old M1); PU Foam Euroclass B-s3,d1 (similar to old M1).
- Very easy to install.

## MODELS AND SIZES

MODELS	HEIGHT	WIDTH	DEPTH	WEIGHT
SLB120	120 cm	30 cm	30 cm	1.4 Kg

## ABSORPTION COEFFICIENT

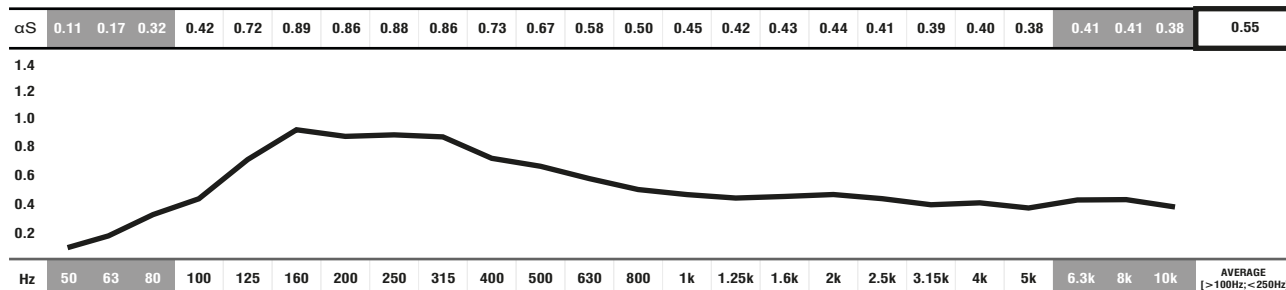

■ ABSORPTION COEFFICIENT: Values in accordance with the standards: EN 20654, ASTM C423 and EN 11654.

■ Values [ $< 100\text{Hz}$  and  $> 5k$ ] are Non Standard Values.

## MELAMINE FACED BOARD FINISHINGS



## REGULAR FOAM COLOURS

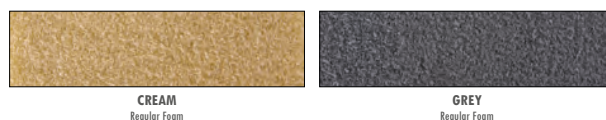

## IMPORTANT NOTICES

- JOCAVI® accepts no responsibility for any printing errors. Specifications can be modified without prior notice, if technical or commercial reasons so require.
- The colours shown on this catalogue are only a reference and an illustration of the products finishing. The colours shown are not binding because brightness, contrast and colour balance may vary due to the printing process.
- Colours may vary due to raw-material suppliers' changes and some differences may occur in total range.
- Due to its natural origin, wood-based products will always present natural imperfections inherent to the organic nature. And for similar reasons, they will also present traces of old-age in the course of time.
- Wood and Fabric products are highly susceptible to change its appearance with humidity and temperature. Close attention must be paid to the storage conditions and the acclimatization before, during and after the installation.
- Typical Indoor Comfort Standards state a temperature range of 20°C - 27°C (68°F - 81°F), and a relative humidity of less than 60%. These would be considered as normal operational levels of JOCAVI® products' range.
- Despite all the standard sizes of all products, this model can be customised upon previous consultation. Sizes may vary slightly due to their production method and some inherent raw-materials characteristics.



# LF TONE®

TUNED ABSORBENT PANEL

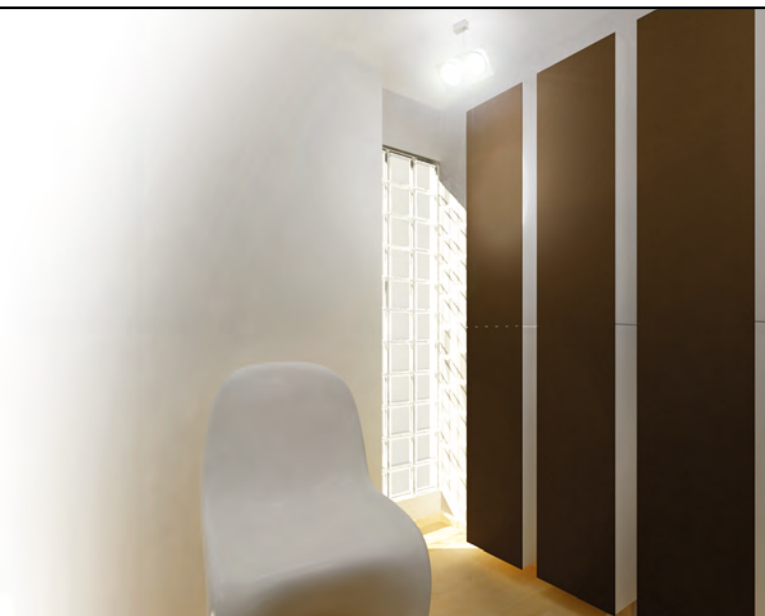

Image of 120x40cm model Ref.:LFT120 (on the left) and Ref.:LFT120 applied (ambient image).

## DESCRIPTION

The LF TONE® is a low-frequency membrane absorbent panel to be used on walls or ceilings. It was conceived as a whole box and with a membrane designed to provide more sensitivity to the low pressure sound waves. It is tuned tot 250Hz and it also has an effective performance at lower frequencies.

The finishing of the LF TONE® is made from JOCAVI®'s fabric and it can be matched with any other fabric finishing models with the same aesthetics.

The LF TONE® aims to reduce the acoustic anomalies caused by the excess of low frequencies and it takes perfect control of the basses specially in music rooms, studios, home-theatres, rehearsal rooms, etc.. It provides one of the best choices among the low-frequency ATP® products.

It can be directly glued to the existing surfaces by using our recommended adhesive glue.

## TECHNICAL DRAWINGS

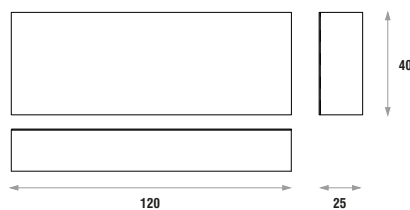

## FEATURES

- Fabric-coated acoustic regular foam on a rigid framework.
- Average absorption: **0.65/m²** [ $>63\text{Hz}; <500\text{Hz}$ ].
- Tuned to 250 Hz.
- Fire-resistance: Fabric - Euroclass B (similar to old M1); EPS - Euroclass B-s3,d1 (similar to old M1).
- Several colours.
- Very easy to install.

## MODELS AND SIZES

MODELS	HEIGHT	WIDTH	DEPTH	WEIGHT
LFT120	120cm	40 cm	25 cm	1.7 Kg

## ABSORPTION COEFFICIENT

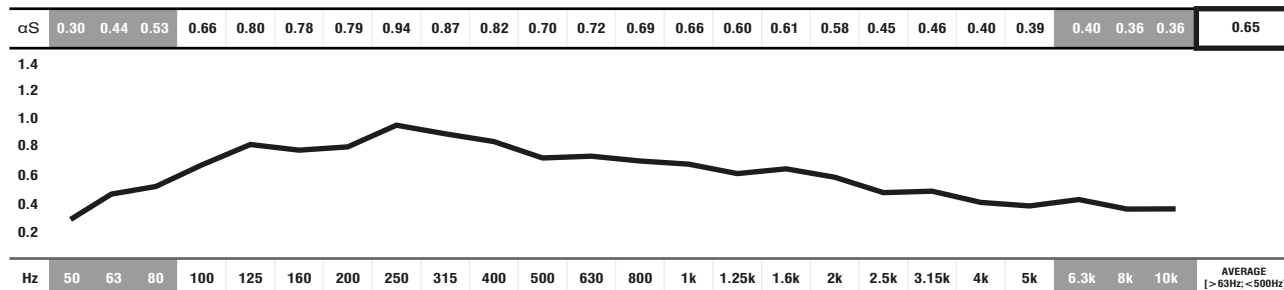

■ ABSORPTION COEFFICIENT: Values in accordance with the standards: EN 20654, ASTM C423 and EN 11654.

■ Values [ $<100\text{Hz}$  and  $> 5\text{K}$ ] are Non Standard Values.

## STANDARD FABRIC COLOURS

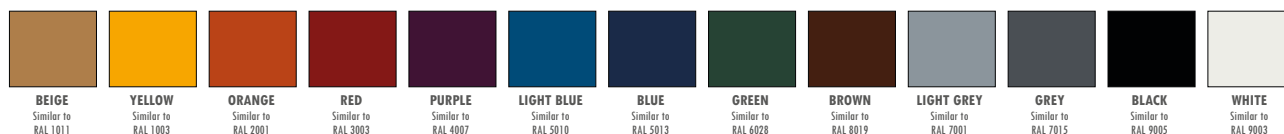

## IMPORTANT NOTICES

- JOCAVI® accepts no responsibility for any printing errors. Specifications can be modified without prior notice, if technical or commercial reasons so require.
- RAL® is an international independent colour standard system partner for industry, trade, architecture and design. Should be consulted before placing any order.
- The colours shown on this catalogue are only a reference and an illustration of the products finishing. The colours shown are not binding because brightness, contrast and colour balance may vary due to the printing process.
- Colours may vary due to raw-material suppliers' changes and some differences may occur in tonal range.
- Typical Indoor Comfort Standards state a temperature range of 20°C - 27°C (68°F - 81°F), and a relative humidity of less than 60%. These would be considered as normal operational levels of JOCAVI® products' range.
- Sizes may vary slightly due to their production method and some inherent raw-materials characteristics.



# SOME WORLDWIDE WORKS



Rehearsal Rooms



Acoustic Shells



Pavilions

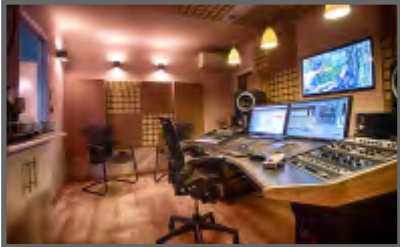

Recording Studios



Concert Halls



Auditoriums



Night C lubs

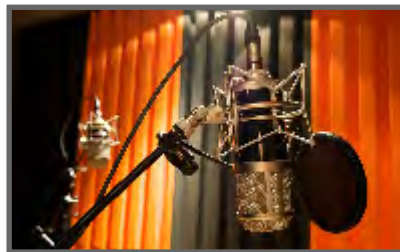

Radio Stations



Health Clubs



Home Theatre / Cinema



Class Rooms

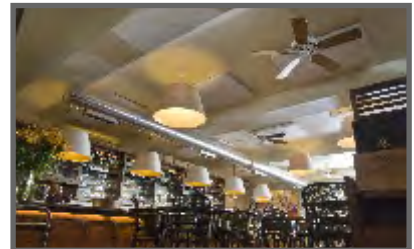

Restaurants



Anechoic Chambers



Food Courts



Mastering Studios



JOCA VI, Acoustic Panels, Ltd.  
 Av. Pedro Álvares Cabral  
 Centro Empresarial Sintra - Estoril V, Armazém B18  
 2710 - 297 Sintra - Portugal

Phone +351 21 9 243097 - Fax +3 51 21 9 243098  
[www.jocavi.net](http://www.jocavi.net) - e-mail: [info@jocavi.net](mailto:info@jocavi.net)  
[www.facebook.com/jocavi.net](http://www.facebook.com/jocavi.net)  
<http://www.youtube.com/user/jocavigroup>